



“Getting to know you”

Serene CL-60

Amplified CID Cordless Phone
Training Manual

Nov. 15, 09

CL-60 targeted User Groups

- People with moderate to severe hearing loss
- People with low vision
- People with mobility impairment

Main Feature Overview



- 55+ dB amplification
- Tone control to enhance speech clarity
- Talking Caller ID on big display
- Talking key pad
- Large back-lit buttons
- 3 one-touch speed dials

Controls-Handset Front

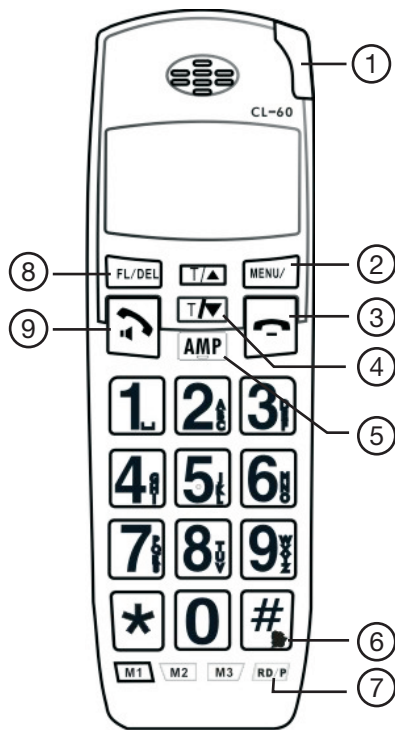

1. Voice mail/missed call indicator
2. Press to access menu; press it again to select option displayed. Or, while on line, press it to mute the microphone on handset
3. Press to hang up. Or, press and hold to turn on/off the power of handset
4. Tone setting selection, up or down. Or, when in menu mode, to navigate up or down
5. To turn amplifier on (lights up) or off
6. Press and hold to turn on/off "Do-not-Disturb" (no ringing on handset)
7. To redial. Or, in memory programming, to insert a pause.
8. Press to receive a waiting call. Or, while in menu mode, to delete a character entry or to go back
9. Press to receive call. Or, while on line, press again to turn on speaker phone

Controls ---Handset sides & back

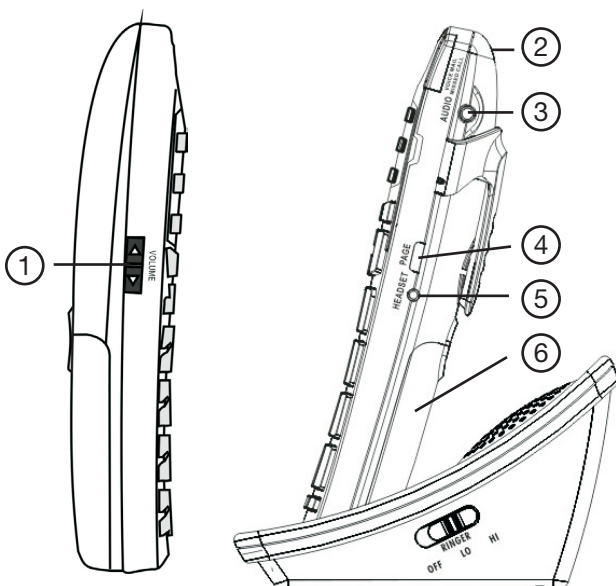

1. Volume up or down
2. Lanyard anchor (lanyard available)
3. Jack for Serene Tele-coil, Neck-loop or other accessories
4. Press to page all handsets
5. Jack for headset
6. Battery compartment (Auto-Amplifier On/Off, Talking CID & Keypad On/Off selection switch inside)

Controls--Base

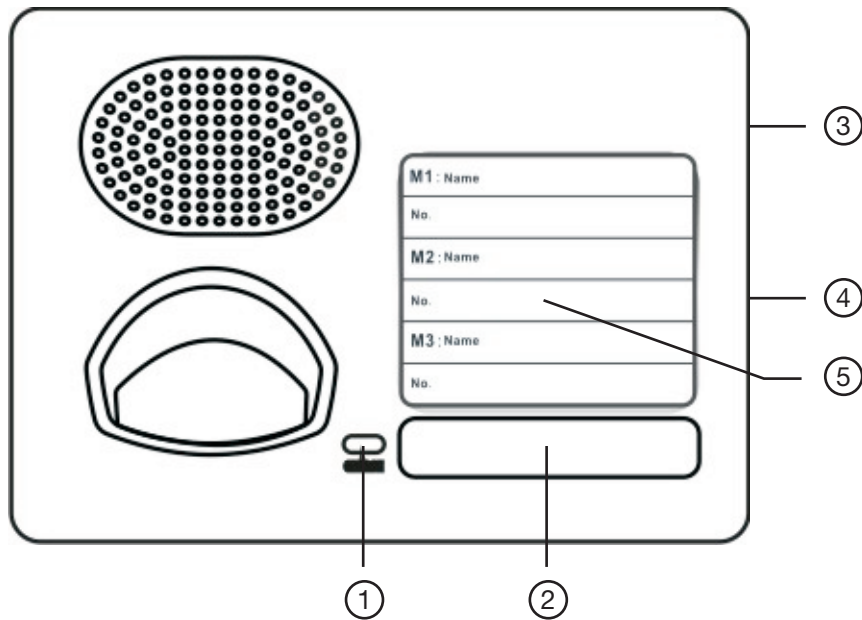

1. Handset charging indicator
2. Page button to page all handsets
3. Back-up battery compartment (underneath)
4. Ringer volume control (Side)
5. Phone directory

Connection & Battery Installation

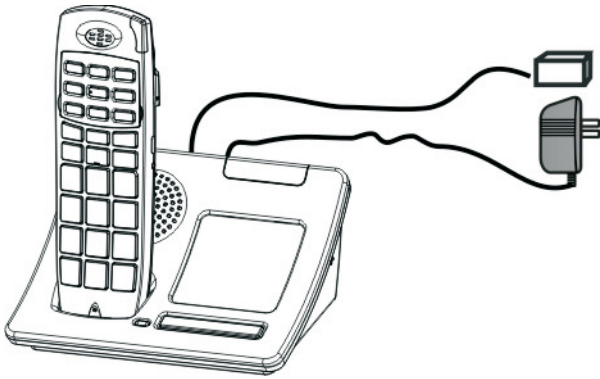





- Connections
- Rechargeable AAA batteries in handset (included)
- Rechargeable AAA batteries (not included) in base as power back-up. These batteries can be used in handset as back-up if needed.



Out of the box feature settings

- Auto Amplifier On/Off: Off
- Talking Caller ID & Key-pad On/Off: On
- Speakerphone volume: Level 3 (of 5)
- Handset volume: Level 2 (of 5)
- Tone setting: T2 (of 4)
- Ringer volume in base: Hi





Making a call from key pad

1. Enter the desired number on key pad
2. Press  to dial out. Or, after it has dialed out, press  again to turn on the speakerphone
3. Press  to hang up
4. To redial the last called number, press  to get on line, then press 

Answering a call

1. Press  to talk. Or, press it again to turn on the speakerphone
2. Press  to hang up



Adjusting Handset Volume

1. While on line, press volume   on the side of handset to increase or decrease volume; it beeps when it reaches its limit
2. If louder volume is desired, press  to turn on (or off) the Amplifier; it lights up when On. If needed, press volume   again to adjust
3. When you hang up, it will reset to the last volume level setting and turn off the Amplifier (unless Auto Amplifier is set to On)





Auto Amplifier On/Off

- Auto On = Amplifier comes on automatically when ever you are on line
- To select, set the “AUTO-AMPLIFIER” switch in the battery compartment to either On or Off

Adjusting Speakerphone Volume

1. While on speakerphone mode, press volume   to increase or decrease volume (level VL1-VL5 as displayed on screen and it beeps when it reaches its limit)
2. The Amplifier is not effective at the speakerphone mode



Adjusting Tone Control

1. While on line and with Amplifier On ( lights up), press  or  to select a tone setting (setting T1 –T4 as shown on display and it beeps at its limits) for best speech clarity
2. When you hang up, it retains the last Tone setting
3. You can adjust the tone setting only when the Amplifier is On ( lights up), and, tone control is not effective in Speakerphone mode

Programming/Dialing from Speed Dial Buttons











1. To program a number---while off-line, enter phone number on key pad
2. Press and hold the disired memory button (M1-M8) until it beeps to save
3. To speed dial--while off line, press the desired memory button (M1-M8), then press  to dial

Programming/Calling your Emergency Contact in M1 (NOT for calling 911)











1. To program your emergency contact number into M1---while off line, enter the phone number and then press  till it beeps
2. To call your emergency contact---just press . It will dial and turn on the speakerphone automatically so you can talk hands-free
3. For real emergency, call 911

Review/Dial/Program from the Received-call Log













(last 40 calls; you must subscribe to phone company Caller ID service)

1. To review --while off line, press  key to see the last received call. Press  to see other received calls in the reverse order
2. To dial the number on display---press 
3. To copy this number into Phone Book---press . When prompted, press  to affirm (it beeps if this number is already in Phone Book); enter name and press  to save. The phone number appears again, press  to save this entry
4. Ring melody assigned to this entry appears and plays; press  to accept and save. Or, press  for other selection; press  to select and save
5. Or, to exist, press 









Review/Dial/Program from the Dialed-call Log

1. To review---while off line, press  to review the last dialed call. Press  to see other dialed calls (list of 10) in reverse order
2. To dial the number on display--- press 
3. To copy this number into Phone Book---press . When prompted, press  to affirm (it beeps if this number is already in Phone Book); enter name and press  to save. The phone number appears again, press  to save this entry
4. Ring melody assigned to this entry appears and plays; press  to accept and save. Or, press  for other selection; press  to select and save
5. Or, to exist, press 



Creating Phone Book Entries (150 max.) from key pad

1. While off line, press , then press  to display PHONE BOOK on screen
2. Press  to select. Then press  to display NEW ENTRY on screen. Press  to select
3. Enter name then press  to save. If you make a mistake in typing, press  to delete
4. Enter number then press  to save
5. Ring melody assigned to this entry appears and plays; press  to accept and save. Or, press  for other selection; press  to select and save
6. Press  to exist





Dialing from Phone Book

1. While off line, press , then  to display Phone Book on screen. Press  to select
2. Press  to display "LIST" on screen. Press  to select
3. Press  or  to scroll
4. To dial number on screen, press 

Receiving a Call Waiting

1. While on line, press  to receive a waiting call and put the current call on hold
2. Press  again to return to the call on hold

Using Voice Mail/Missed-call Indicator

1. Blinking flasher means that there are voice mail messages waiting (paid service from your phone company) or that you have missed a call
2. To check voice mail, press  to get on line. If you hear a stuttered dial tone, that means you have messages waiting. Call your phone company voice mail (a paid service) to retrieve all un-heard messages and the blinking will stop. Blinking will continue as long you have un-heard messages
3. If there is no voice message (no stuttered dial tone), that means you have missed call(s). Press  to show the most recent missed call
4. Press  to scroll to other missed calls. To call the number on display, just press 
5. Once you have viewed all the missed calls, the blinking will stop. But if you have Voice Mail Service, the blinking will continue until you have listened to all your new voice mail messages

To turn off Talking feature

1. Open battery compartment
2. Slide TALKING CID & KEYPAD switch to the Off position. This will turn off the talking voice of Caller ID and key pad















Other features/settings in Menu

1. While off line, press **MENU/⊗** and then press **T/▲** or **T/▼** to scroll to the desired option
2. Press **MENU/⊗** to select the displayed option
3. Follow the prompt and press **T/▲** or **T/▼** to scroll
4. To exist, press **FL/DEL**

Useful CL-60 facts

- Talking distance: up to 300 ft from base in an average house
- Talk time: up to 8 hours
- Stand-by time: 80 hours
- Time required to charge handset: 8 hours
- Battery for handset/base: rechargeable AAA size, inter-changeable between handset and base use
- Extra handsets (item CL-60HS: up to 5, sold separately)

Common FAQ

1. How can I turn off the “talking” voice?
Just set the “talking” selection switch to Off in the battery compartment.
2. How come some keys only talk some of the time, but not all the time?
While off line, these keys talk when pressed--- , , , the complete DIALING PAD, M1-M3 speed dials, . While on line, these keys talk when pressed--- , “MUTE”, , , , 
 , 
3. Can I change the voice level of the talking caller ID?
Yes, while the phone is ringing, press volume   to increase or decrease the talking and ringing volume.
4. What if I don't have CID service?
No problems, the phone will just not voice or show any caller ID info, everything else remains the same.

5. What if I want the amplifier on every time I use the phone?
Just set the Auto-Amplifier switch in the battery compartment to the On position.
6. How do I set the phone so that it is not too loud for the others?
Set the Auto-Amplifier in the battery compartment to Off. Press  button to turn on the amplifier when needed.
7. What if I wear T-coil hearing aids?
Turn on the T-coil in your hearing aids and talk normally. For best results, we recommend you use a Serene Tele-coil or Neck Loop.
8. What if I don't install back-up batteries?
We strongly suggest that you do so; that way, your phone will be 100% operational even when there is a power outage. If not, your phone will not be operational in case of power outage.
9. How long will the back-up battery work?
It will give you up to 4 hours of continuous talk time.
10. Why is the handset blinking?
That means you've missed a call or there is a voice mail message waiting for you.
11. What is that beeping sound?
The handset beeps when you put it in the cradle for charging.

Trouble shooting CL-60

- Charge indicator on base does not light up--Jiggle handset to improve contact
- No Caller ID appears—call your phone company to check on the Caller ID service
- No dial tone--check for secured connection of AC adapter and phone line
- Handset does not ring--low battery, or it is in Non Disturb mode, or the handset power is off
- Blinking flasher on handset--you have missed a call or there is a voice mail message waiting

CL Accessories?

- Serene Tele-coil with microphone, available in single (Item CL9001) or double (item CL9002)
- Serene Neck-loop with microphone (item CL9003)

Toll free Help Line

- (866) 376-9271
- 9AM to 6 PM, Monday-Friday, Pacific Standard Time
- Staffed with live customer service representatives