

Envoy S User Guide

Your Audio Project



Everything you need to prepare an audio project and load it onto the MegaVoice Envoy S audio player.

Table of Contents

Table of Contents.....	2
Table of Figures.....	4
Overview.....	5
Hardware Requirements	5
Software Requirements.....	5
File Structure	6
Structuring Rules.....	6
The Folder Layout	6
Relationship between the Envoy S keypad and folder layout.....	7
Setting up the folder layout.....	10
The Audio Project Folder	10
The Language Folder.....	12
The Section Folders.....	14
The Book Folders and Chapter Files	16
Verifying the Intermediate Folder Structure	21
Renaming the Folders.....	22
Loading audio files to the Envoy S.....	30
Connecting the players for programming	30
Loading the Audio using SaberCopy	31
Listen to the message	37
The Bookmark.....	38
Setting the Bookmark.....	38
Resetting the Bookmark to the beginning.....	38
Battery care and charging.....	39
Charging and communication modes.....	40
Warnings and advisories.....	41
MegaVoice limited warranty	42
Technical Support	44
Troubleshooting.....	45
Troubleshooting continued.....	46
Resetting the player.....	46

Table of Figures

Figure 1: Folder layout for Envoy S.....	6
Figure 2: Relationship between the keypad and folder layout	7
Figure 3: Section navigation button	8
Figure 4: Book navigation buttons	8
Figure 5: Chapter navigation buttons.....	9
Figure 6: Current chapter and pause navigation buttons	9
Figure 7: Folder layout before/after renaming	29
Figure 8: USB connection diagram	30
Figure 9: SaberCopy Copy and Check options	34
Figure 10: On/Off button.....	37

Overview

The Envoy S - one of MegaVoice's most innovative and intuitive solar digital audio players yet. Cost effective and smaller than a smartphone, the 2.4 ounce Envoy S is lightweight and also the most powerful teaching and training tool available. The intuitive raised-button keypad with four levels of navigation makes searching hundreds of hours of audio Bible content easy and accessible - even for the elderly or blind.

The Envoy S comes with onboard memory, which is programmable through the USB port with SaberCopy software, making it simple and secure for your ministry to update content. USB hubs allow for multiple players to be loaded at the same time.

The Envoy S holds up to 800 hours of tamperproof audio content including: audio Bible, New Testament, sermons, discipleship training, music, educational or humanitarian messages, and more. The optional Solar Case Speaker is available for listening in larger groups.

Hardware Requirements

- ✦ A Windows PC or Mac (Intel only)
- ✦ At least one USB port (2.0 or higher)
- ✦ Enough disk space for...
 - ✦ The SaberCopy software program (around 10 MB)
 - ✦ Each of your audio messages
 - ✦ Additional work area for restructuring message folders
- ✦ One SLS USB cable per parallel connected player (available from MegaVoice)
- ✦ A powered USB 2.0 (or higher) hub (optional – for programming multiple players concurrently)

Software Requirements

- ✦ [SaberCopy software \(available from MegaVoice\)](#)
- ✦ PC Operating System: Windows 7, 8.x or 10 (SaberCopy will work on XP but is not recommended since XP is no longer supported)
 - ✦ SaberCopy can work on Mac with certain restrictions ([see here for details](#))

File Structure

Structuring Rules

Please refer to the Folder Layout illustration below.

- ❖ All audio files must be in MP3 or WAV format.
- ❖ Your audio project must be set up with a special folder layout.
 - Within your audio project folder must be 1 (and only 1) language folder.
 - Within each language folder must be at least 1 (and up to 8) Section folder(s).
 - Within each Section folder must be at least 1 (and up to 999) Book folder(s).
 - Within each Book folder must be at least 1 (and up to 999) MP3/WAV audio file(s).
 - The Language, Section and Book folders must be named with a 3 digit number beginning with 001.
 - The MP3/WAV audio files may be named with free text – *as long as* they sort in the order they should be played.

The Folder Layout

Figure 1: Folder layout for Envoy S

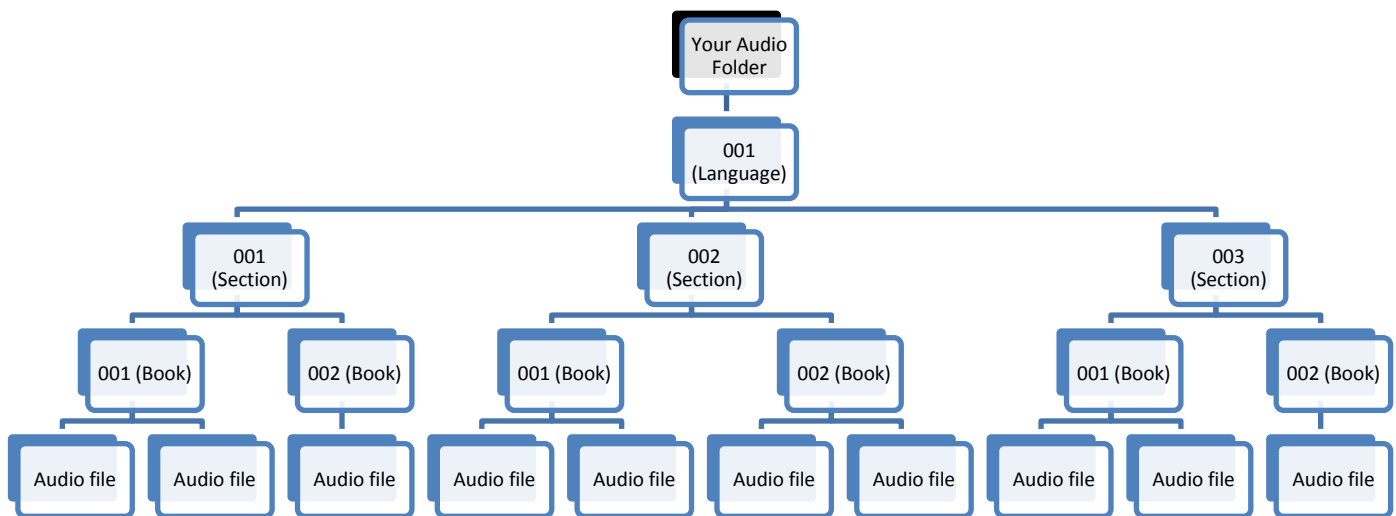

Relationship between the Envoy S keypad and folder layout

The Envoy S offers convenient navigation through hundreds of MP3/WAV files. In order for this navigation to work, you need to decide how you want your files to be partitioned.

Let's get to know the Envoy S keypad and how the navigation buttons correlate to the required folder structure.

Figure 2: Relationship between the keypad and folder layout

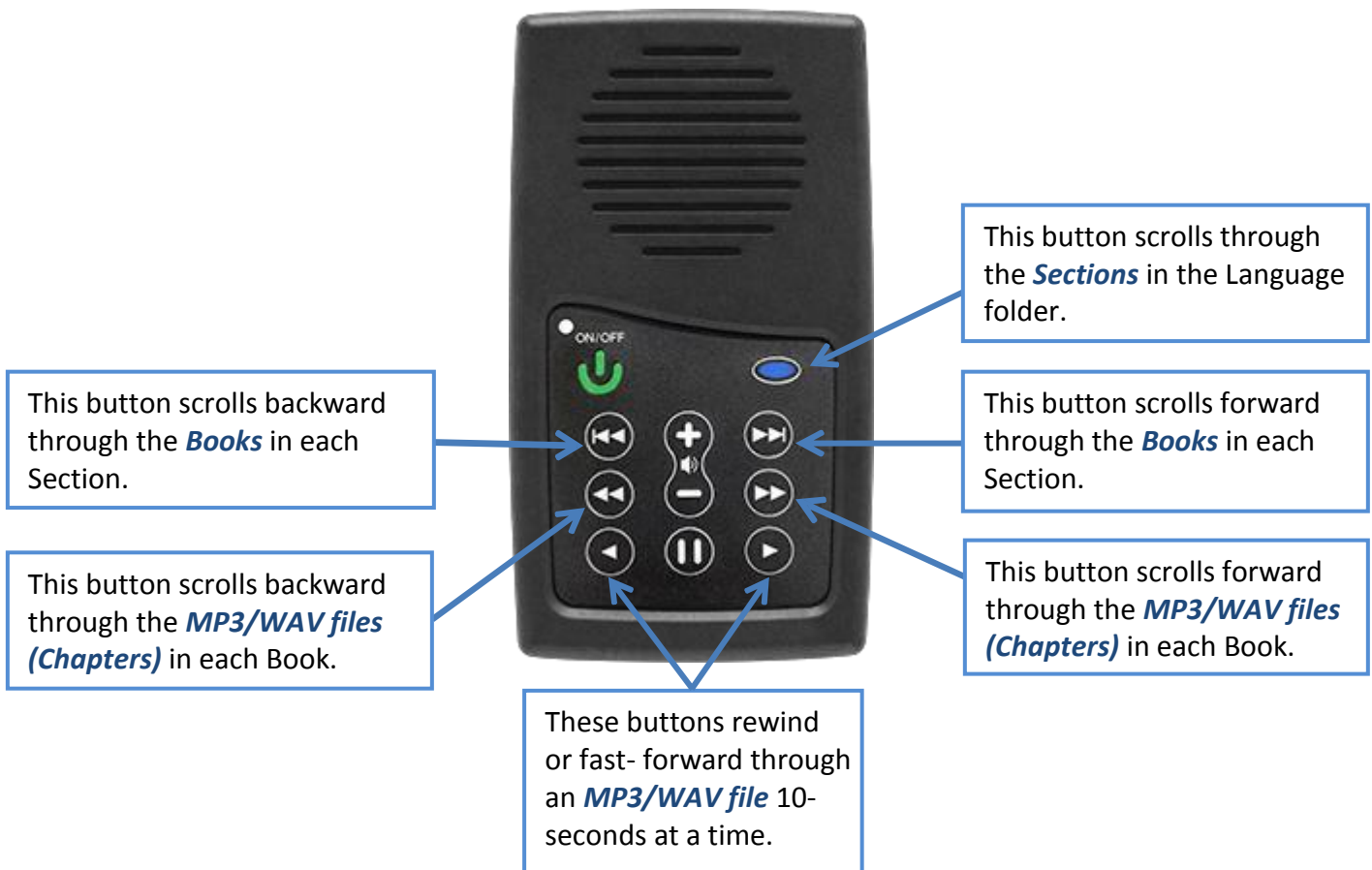

For those of you who are familiar with MP3 players or smartphones, it may be helpful to consider how we organize our music: **Artists, Albums and Songs**.

We group our songs in albums and the albums are grouped per artist. We have a very similar structure for the files on the Envoy S! MP3/WAV files are grouped into “Books” and Books are grouped into “Sections”.

A typical Bible from the MegaVoice Audio Library is divided into 3 *Sections* in the following way:

- **001** Genesis through Job 18 “Books”
- **002** Psalms through Malachi 21 “Books”
- **003** Matthew through Revelation 27 “Books”

Figure 3: Section navigation button



A *short press* on the blue button will scroll to the *next* Section. From the last Section it will scroll back to the first. There may be up to 8 Sections.



Each Section may contain one or more “Books”. The  and  buttons control reverse/forward navigation through the Books.

Figure 4: Book navigation buttons



A *short press* on one of these buttons will scroll to the previous/next Book in the current Section.

When the first/last Book in the current Section is reached, a *short press* will navigate to the last/first Book in the previous/next Section.

A *long press* will skip 3 Books at a time.

Each Book may contain one or more “Chapters”. The ◀◀ and ▶▶ buttons control reverse/forward navigation through the Chapters.

Figure 5: Chapter navigation buttons



A *short press* on one of these buttons will scroll to the previous/next Chapter in the current Book.

When the first/last Chapter in the current Book is reached, a *short press* will navigate to the last/first Chapter in the previous/next Book.

A long press will skip 5 Chapters at a time.

The ◀ and ▶ buttons control rewind/fast-forward navigation through the current audio file (Chapter). The ⏸ button allows you to pause audio playback.

Figure 6: Current chapter and pause navigation buttons



A *short press* on one of these buttons will rewind or fast-forward through the current audio file (Chapter), 10 seconds* at a time.

A *long press* will continue to rewind/fast-forward until the button is released or the beginning/end of the file is reached.

**The actual time may vary slightly.*

A click on this button will create a bookmark in the current audio position and place the player in pause mode.

Setting up the folder layout

The Audio Project Folder

Let's use the following example. We have sets of Audio Bibles in different languages, but the structure is such that all the audio files for each Bible are together in a single folder. The individual audio files are named such that they are easily recognizable and they also sort in the order in which they should be played but that is the extent of the organization. Your audio messages may be organized differently.

We have a folder named "Audio Bibles". Within that folder we have 3 Bibles each in a folder of its own: a Dutch New Testament (Dutch-NT), an English New Testament of the KJV translation (English-NT-KJV) and a Spanish New Testament (Spanish-NT).

Within each Bible folder are all the relevant audio files (MP3/WAV), which are Chapters of the various Books. To keep the files ordered within the single folder, our naming convention is:

BibleName-BookNumber-BookName-ChapterNumber

Let's take the English-NT-KJV audio message and prepare it for the Envoy S. In order to keep the example simple, please note that only select Book and Chapter files appear. We have the first 3 Chapters of the Books Matthew, Mark, 1 Corinthians, 2 Corinthians, Jude and Revelation.

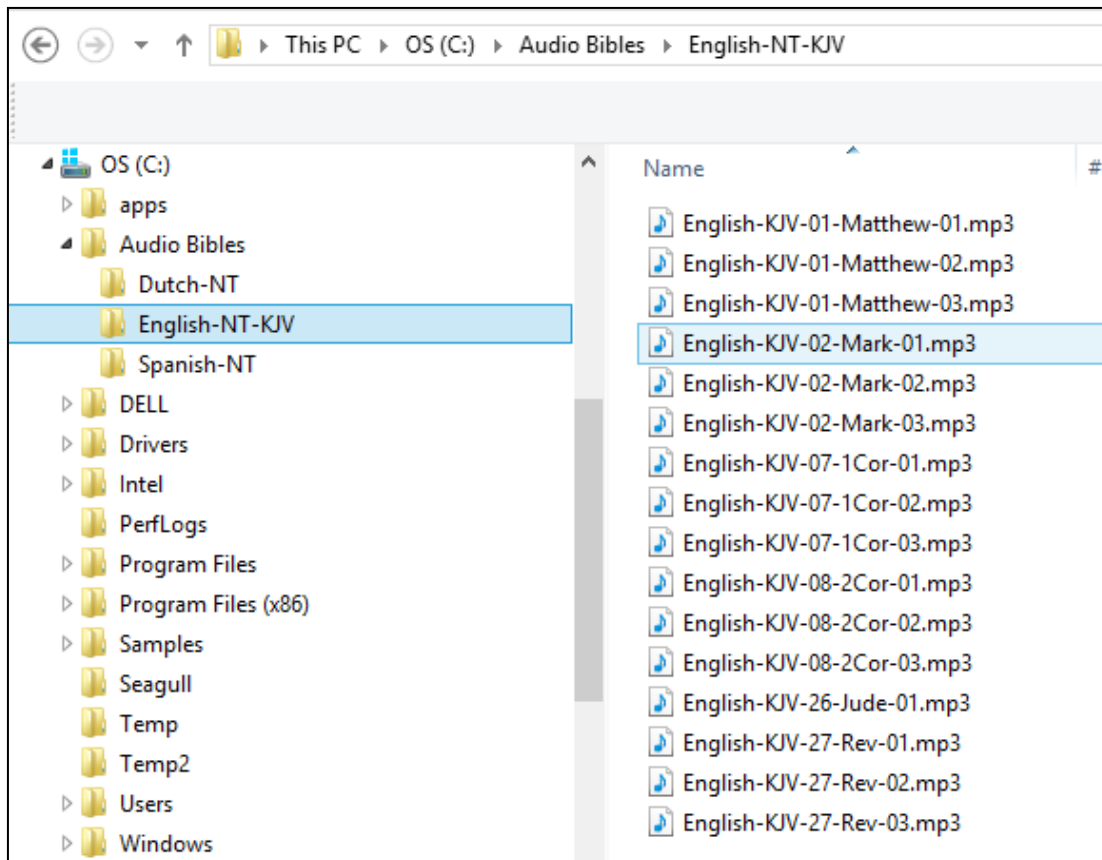



In order to load the Envoy S with an audio project, it will be necessary to rename and/or reorganize the folders. Before you begin making changes to your Audio Project Folder, MegaVoice recommends that you make a copy of your project folder and make changes *to the copy* to keep your original folder intact. Then use the copy for loading the players.

So let's create a new folder within our Audio Bibles folder and call it MegaVoice. From this point on, we will refer to that folder as the **Audio Project Folder**. We'll copy the contents of the English-NT-KJV folder into it and make our changes here.

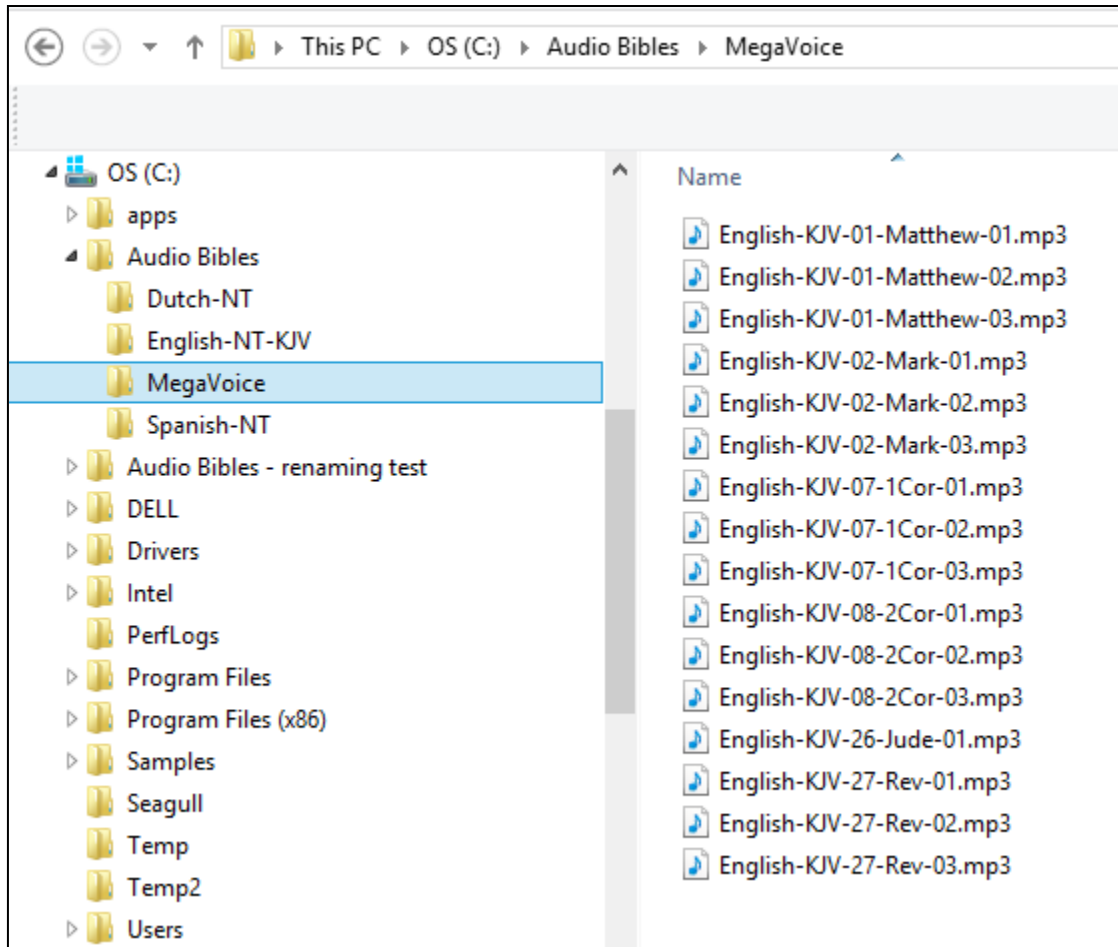

As mentioned earlier, we need to end up with the following required structure:

- Audio Project Folder
 - Language Folder (only one named “001”)
 - Section Folder 1 (named “001”)
 - Book Folder 1 (named “001”)
 - Book Folder 2 (named “002”)
 - And so on...
 - Section Folder 2 (named “002”)
 - Book Folder 1 (named “001”)
 - Book Folder 2 (named “002”)
 - And so on...
 - And so on...

The Language Folder

First let’s create the Language Folder in the MegaVoice folder. For the Envoy S, there is only one language folder and it must be named “001”. Since we will end up with lots of folders with the same 3-digit sequence number, we will append a meaningful name to help us distinguish between them all. Let’s name it “001-Language- English”.

In a later step using a recommended file “renaming” utility we will remove the “meaningful” part of the folder names – but only after the folders are organized properly.

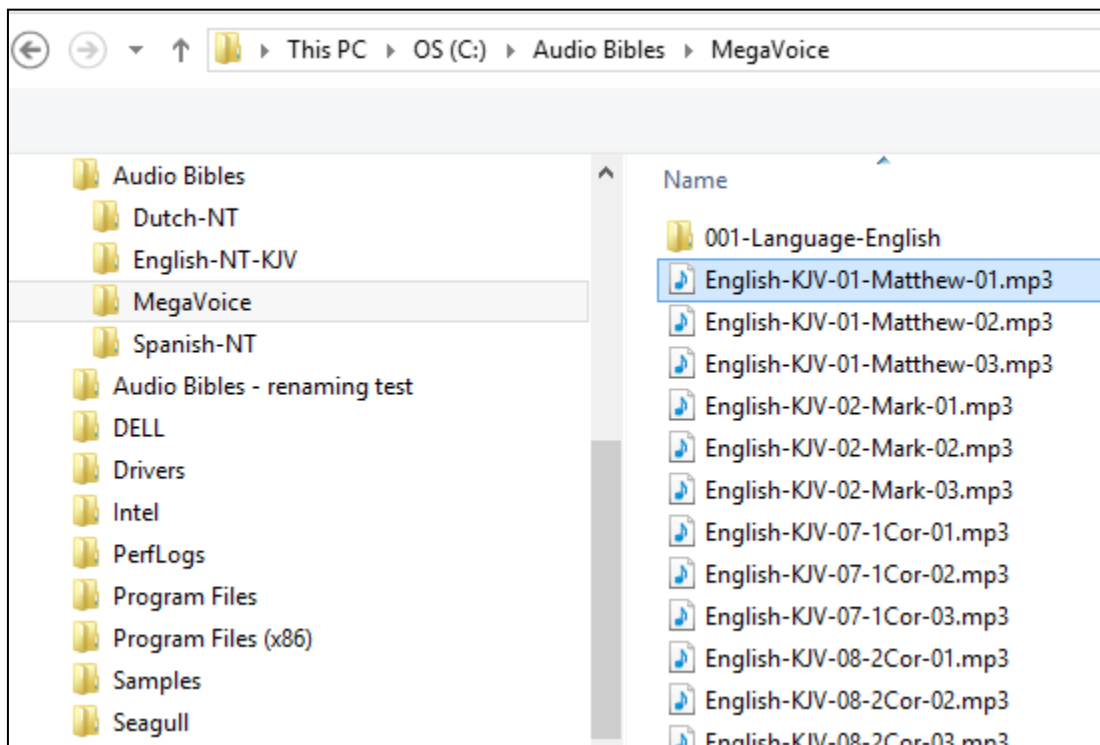

Now let's move all the MP3/WAV files into the new folder "001-Language-English". There are several ways to do this. Use the method you are most comfortable with.

- Highlight all the MP3/WAV files, right-click and choose "Cut", open the "001-Language-English" folder, right-click and choose "Paste".
- Highlight all the MP3/WAV files and then "drag" them to the "001-Language-English" folder and "drop" them.

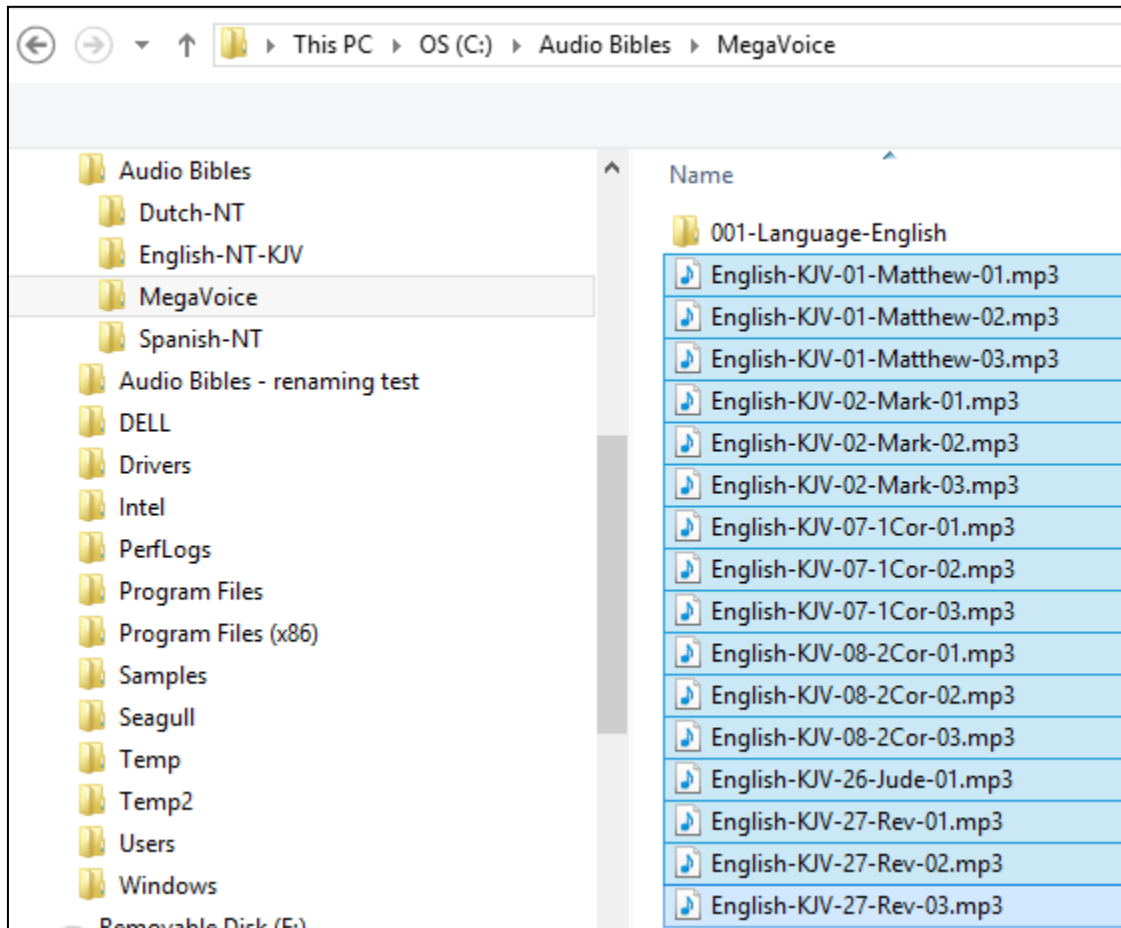

The MegaVoice folder will now contain only the "001-Language-English" folder.

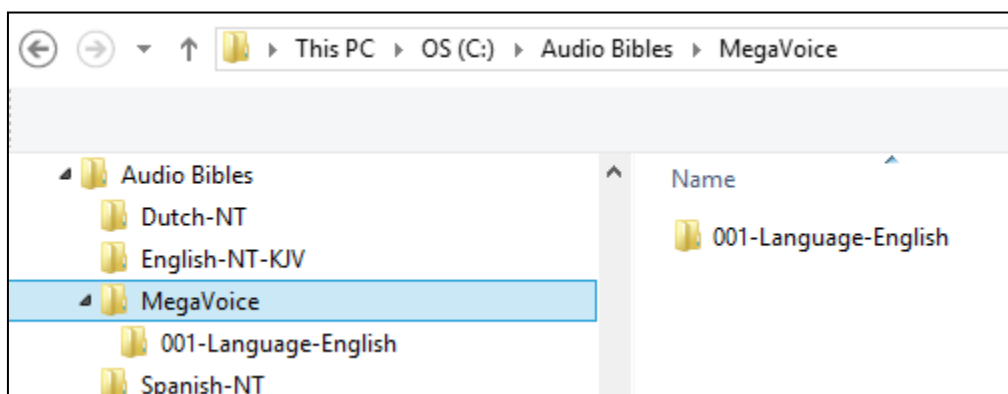

The Section Folders

Open the “001-Language-English” folder. Now we decide how we want to group our “Books” into Sections. In this example, we have only 6 Books: Matthew, Mark, 1 Corinthians, 2 Corinthians, Jude and Revelation. We want 3 Sections where the first contains Matthew and Mark, the second contains 1 and 2 Corinthians and the third contains Jude and Revelation.

In the Language folder, let’s create the following Section folders: “001-Section-Matthew-Mark”, “002-Section-1-and-2-Cor” and “003-Section-Jude-Rev”.

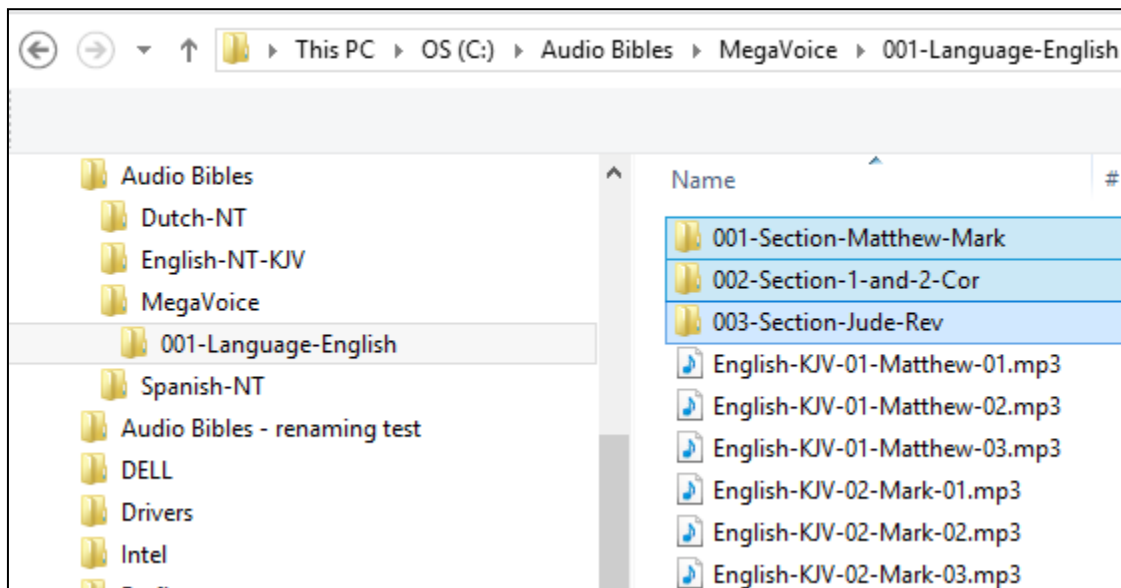

Once our Section folders are created, let's move corresponding audio files to their respective Section folder. Move all the Chapter (MP3/WAV) files for Matthew and Mark to the "001-Section-Matthew-Mark" folder. Move all the Chapter files for 1 and 2 Corinthians to "002-Section-1-and-2-Cor". Move all the Chapter files for Jude and Revelation to "003-Section-Jude-Rev".

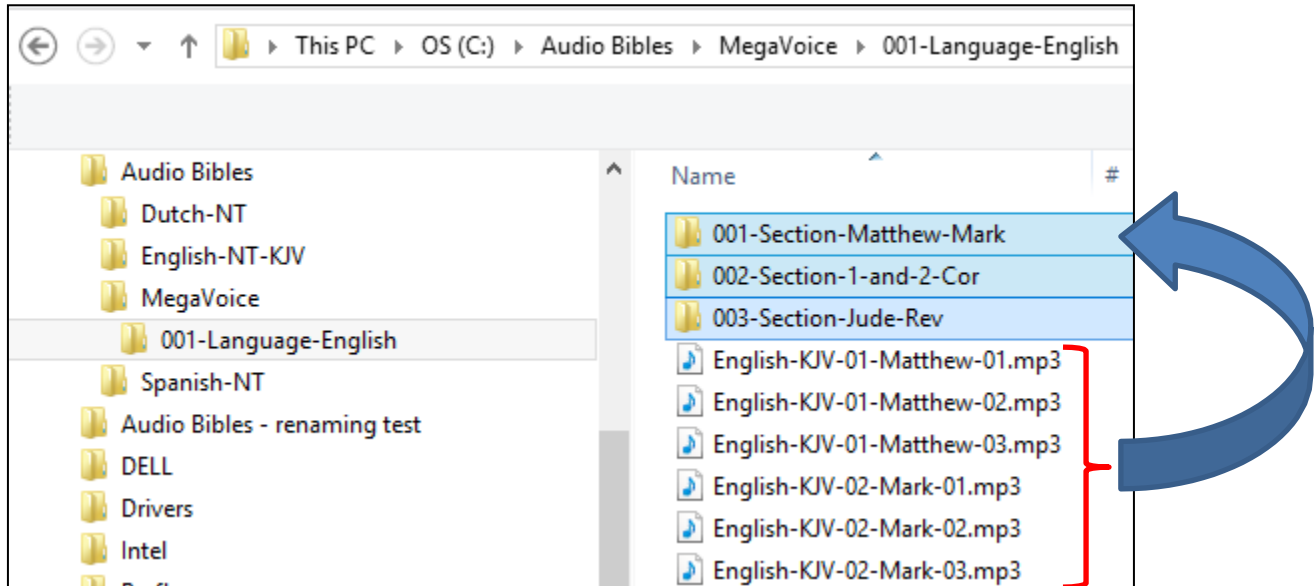

Once you do this, all that the "001-Language-English" folder should contain is our three Section folders.

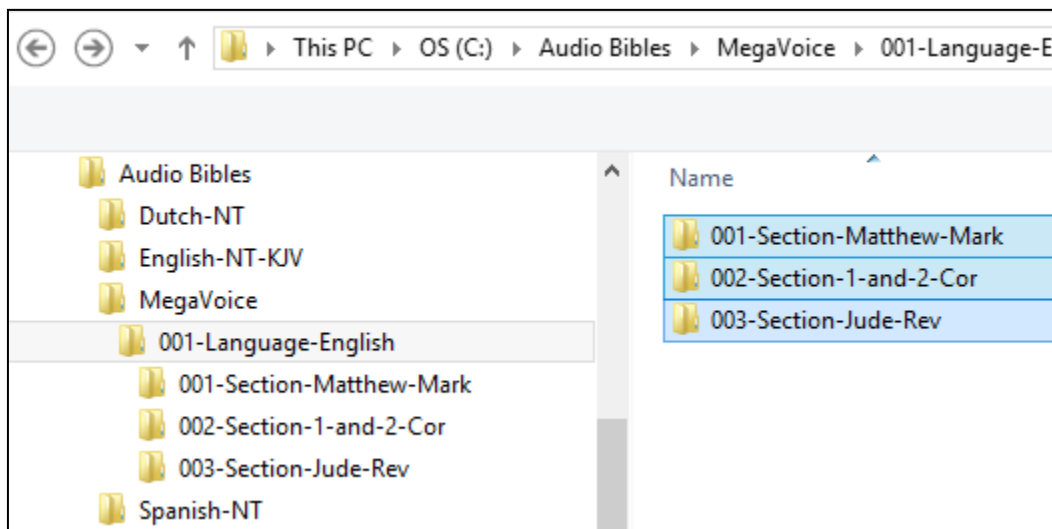

The Book Folders and Chapter Files

Now we will create “Book” folders in each of the three Section folders. Open the first Section folder, “001-Section-Matthew-Mark”. Since Matthew is the first Book, create a folder named “001-Matthew”. Mark, being the second Book, will need a folder named “002-Mark”.

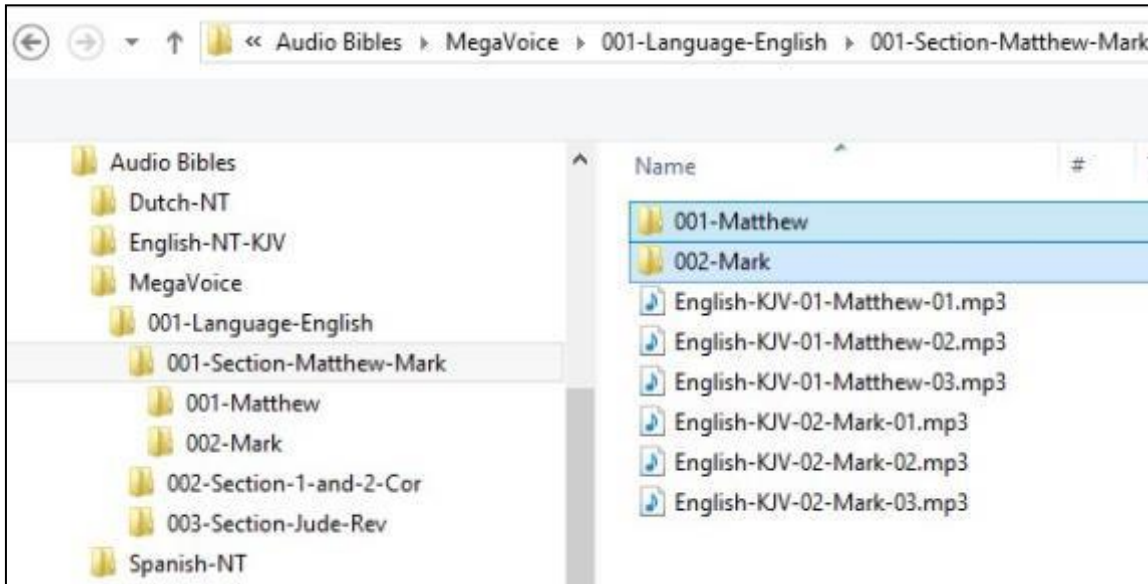

Now we will move the Chapter files to their respective “Book” folders. Highlight the Chapter files for Matthew (3 of them in our example) and move them to the “001-Matthew” folder. Highlight the Chapter files for Mark (3 of them) and move them to the “002-Mark” folder.

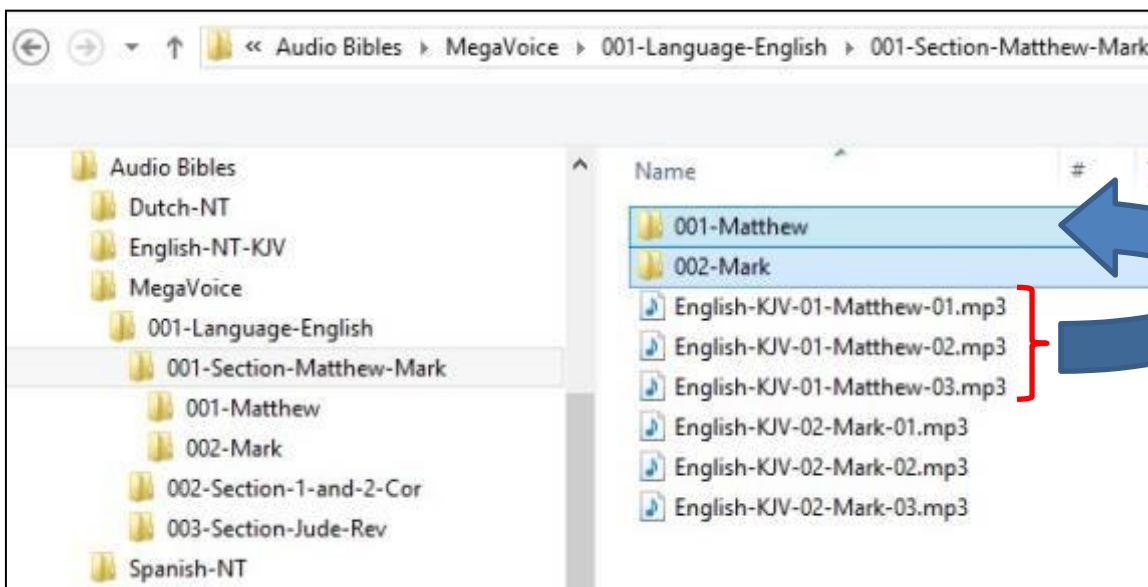

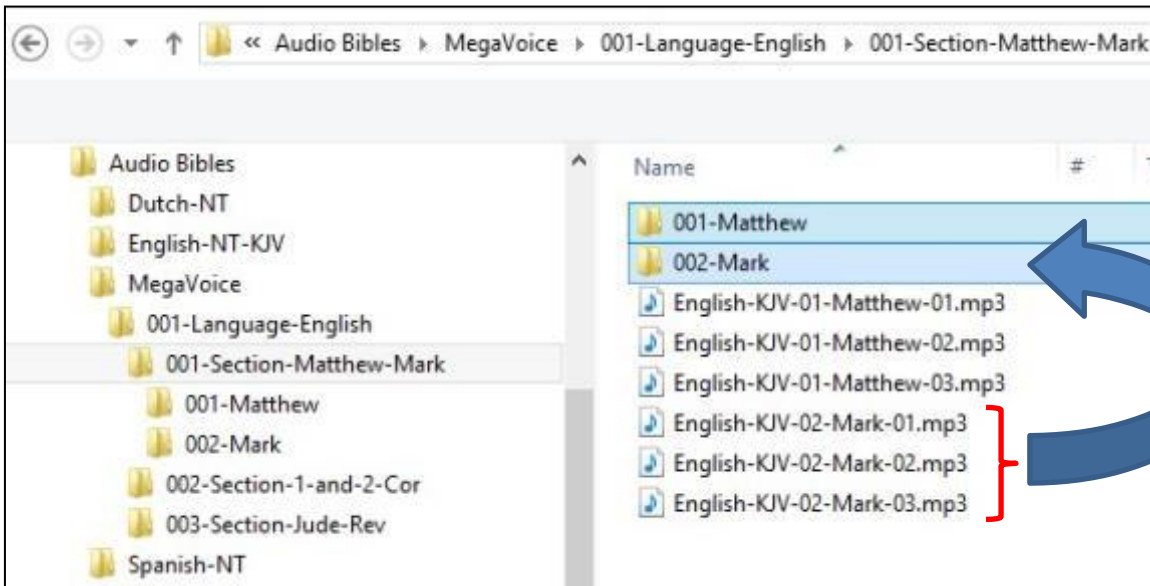

Let's repeat the above process for the next Section, "002-Section-1-and-2-Cor". Because 1 Corinthians is the first Book in this Section, create folder "001-1-Corinthians". And create "002-2-Corinthians" for the second Book.

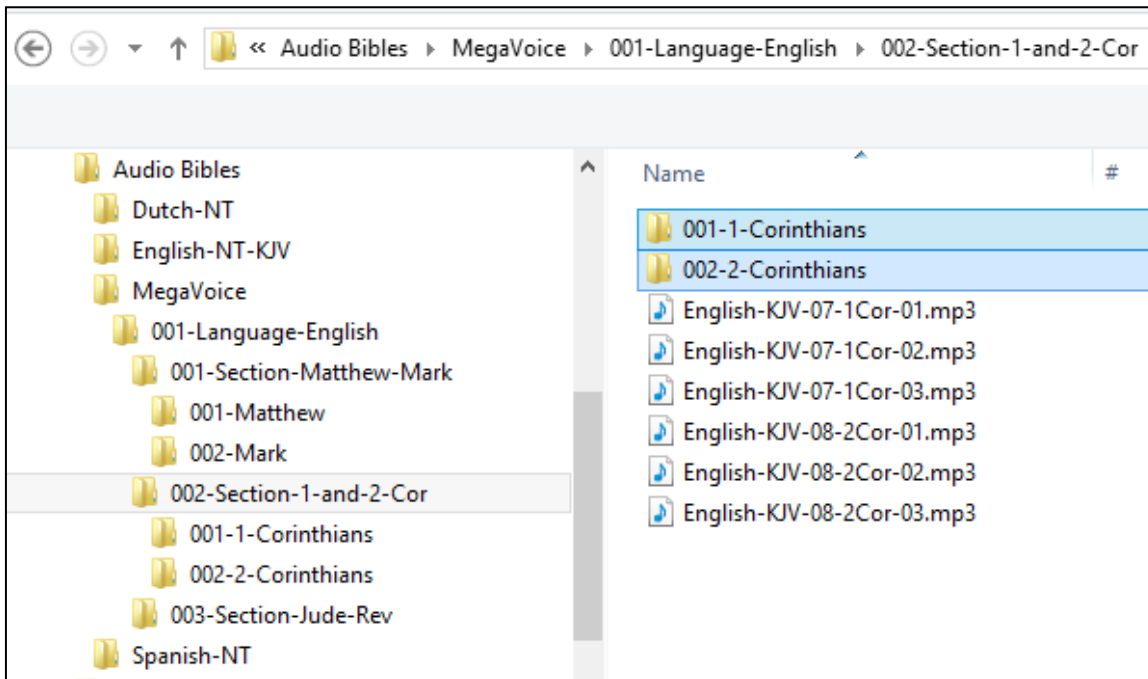

Again we will move the Chapter files to their respective “Book” folders. Highlight the Chapter files for 1 Corinthians (3 of them in our example) and move them to the “001-1-Corinthians” folder. Highlight the Chapter files for 2 Corinthians (3 of them) and move them to the “002-2-Corinthians” folder.

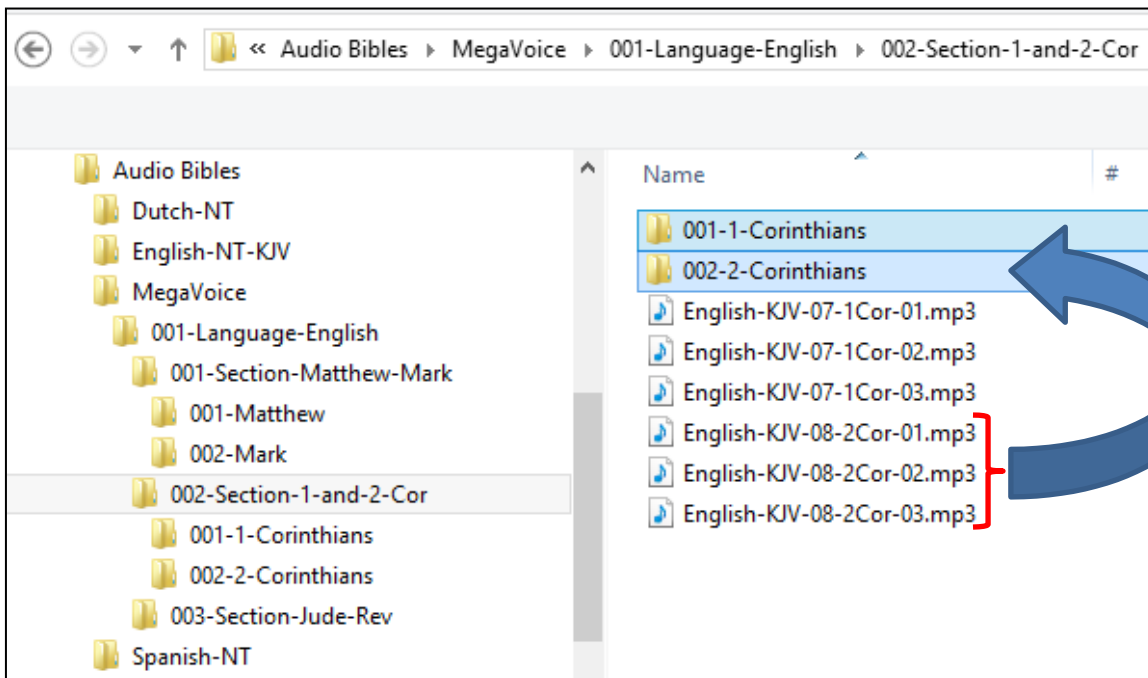
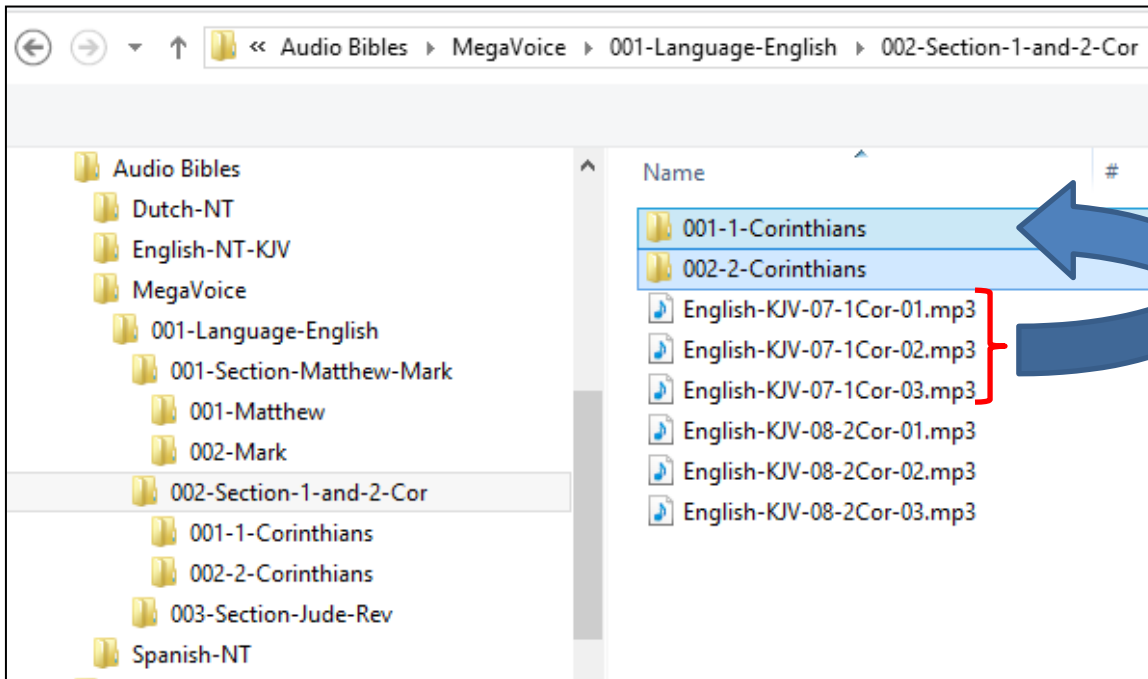

And finally, repeat the process for the third Section, “003-Section-Jude-Rev”. Open the folder and create a Book folder for Jude, “001-Jude” and create a folder for Revelation, “002-Revelation”.

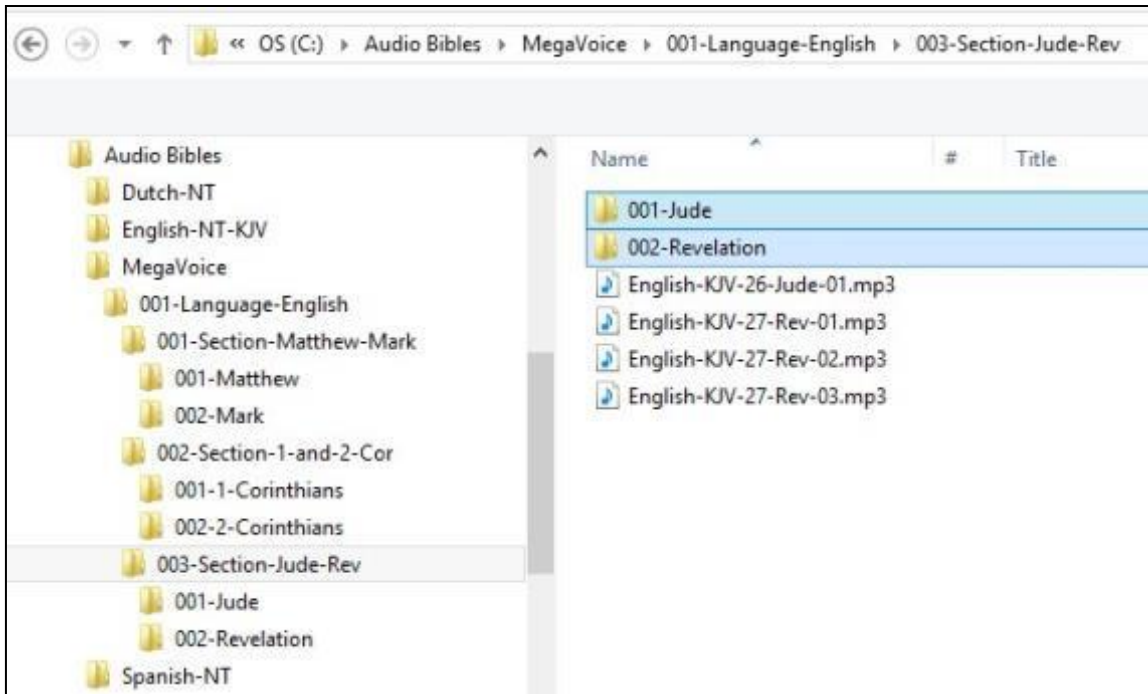

Let's move the Chapter files to their respective "Book" folders for Section 3. Highlight the (only) Chapter file for Jude and move it to the "001-Jude" folder. Highlight the Chapter files for Revelation (3 of them) and move them to the "002-Revelation" folder.

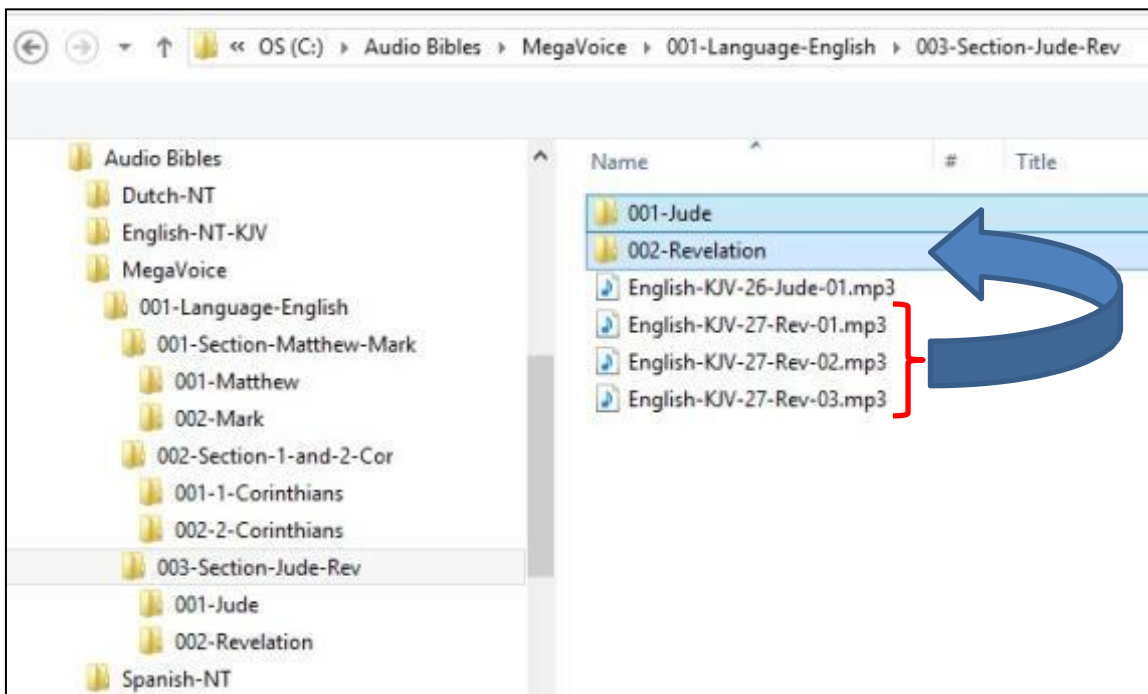
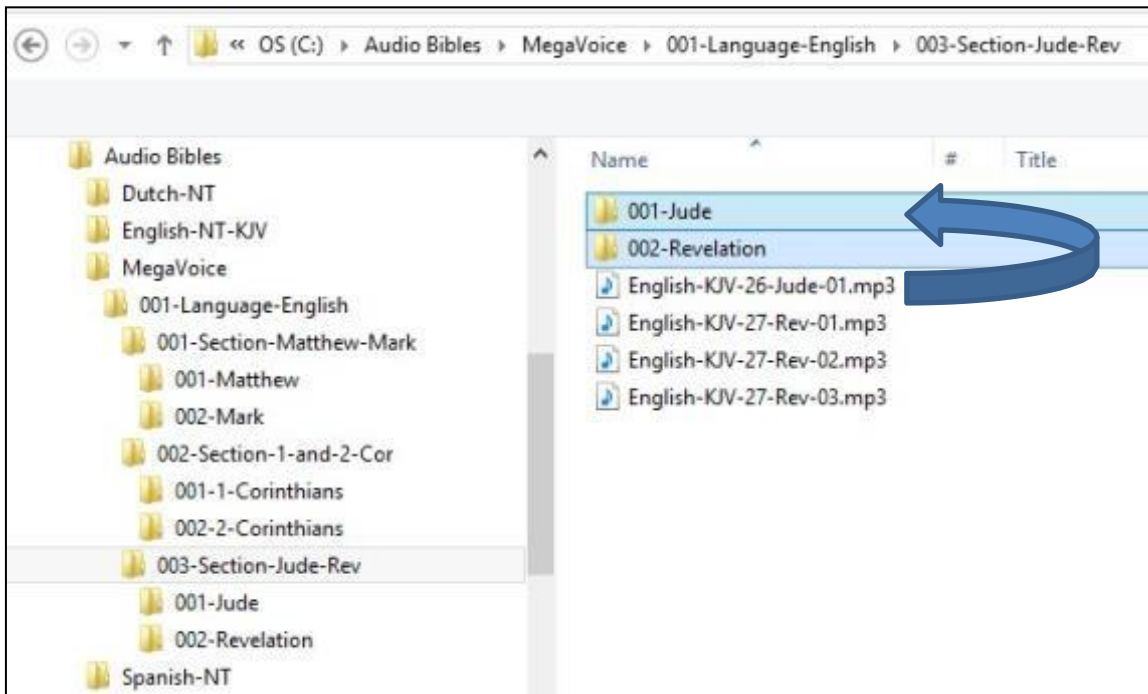

Verifying the Intermediate Folder Structure

Let's verify what we have so far. Using names that were a combination of the required 3-digit sequence number and a meaningful name should make this easy.

Within our Audio Project Folder "MegaVoice" we should only have one folder which is our Language folder.

Within the Language folder we should only have our three Section folders.

Within each Section folder, we should only have Book folders and they should be the Books relevant to that particular Section.

Within each Book folder we should have the relevant Chapter (MP3/WAV) files for that Book. The Book folders are the only place in the Audio Project Folder where MP3/WAV files are present.

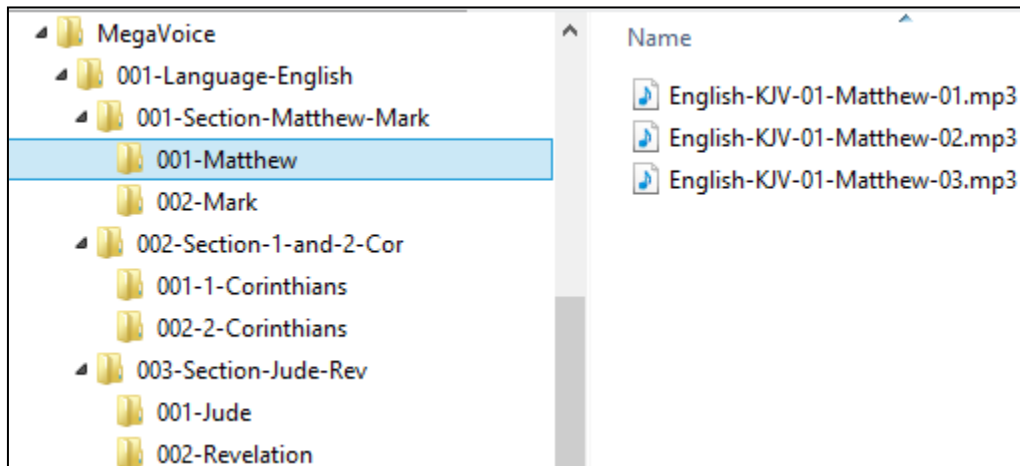

Renaming the Folders

Now that we have validated our folder structure along with the contents of each, we need to rename our folders to the required 3-digit names.

Because our example is a very simple one, we could easily do this manually using the File Explorer on our PC or Mac. But since most audio projects will have hundreds of audio files spread throughout very many folders that could be quite a tedious task and prone to error.

MegaVoice recommends a free file renaming utility that you can install on your PC or Mac. It can be used to rename either files or folders. If you need it, download and install the software.

<http://sourceforge.net/projects/freefilerenamer/>

We'll demonstrate how to use this utility to rename our folders. Because the audio files (MP3/WAV) were already named so that they sorted correctly, they can be left as they are.



Before renaming the folders, MegaVoice recommends that you make *another* backup your audio folder. Preserving the longer meaningful names can help later when trying to troubleshoot problems caused by audio files getting accidentally misplaced in the wrong folders or if there is a need to change the structure.

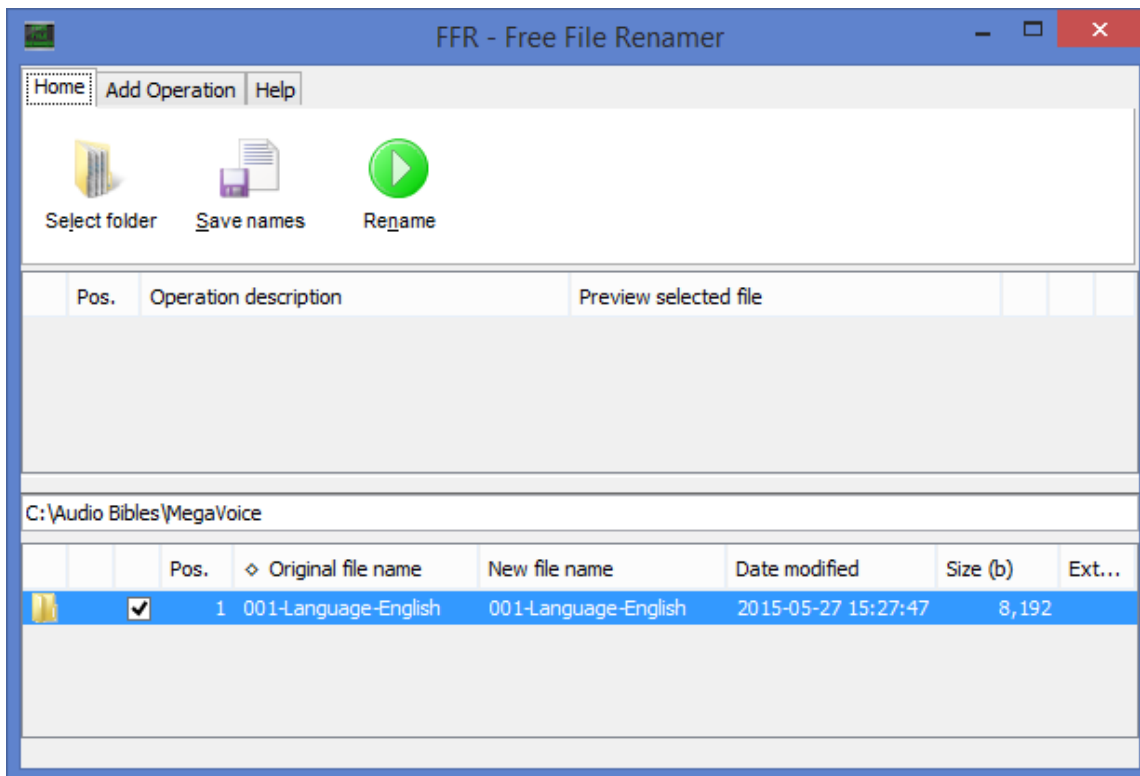

Let's get started. The first thing we need to do is to identify the folder(s) we wish to rename. Free File Renamer can only rename files or folders in a single folder at a time.

On the main screen, make sure you are on the "Home" tab. Click the "Select folder" icon.

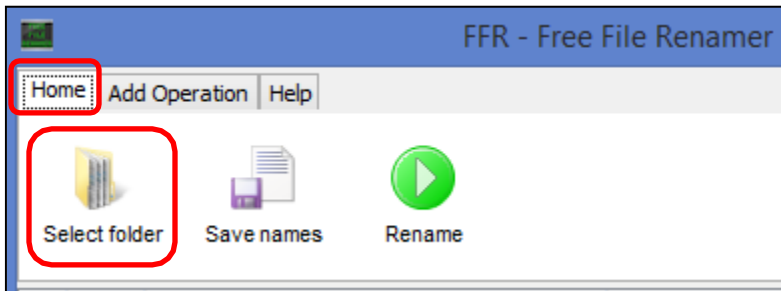

The "Open" dialog appears. We can rename our folders in any order desired. Let's start with the Book folders in each Section folder, followed by the Section folders and finally the Language folder. Navigate to \Audio Bibles\MegaVoice\001-Language-English folder. Highlight the first Section folder "001-Section-Matthew-Mark" and click "Open".

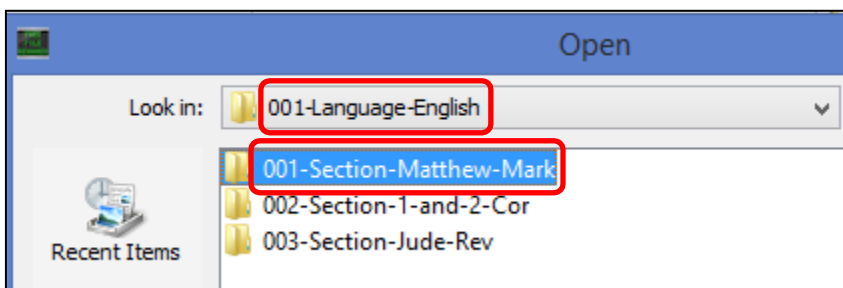

In the selected Section folder, we should see the 2 Book folders, “001-Matthew” and “002-Mark”.

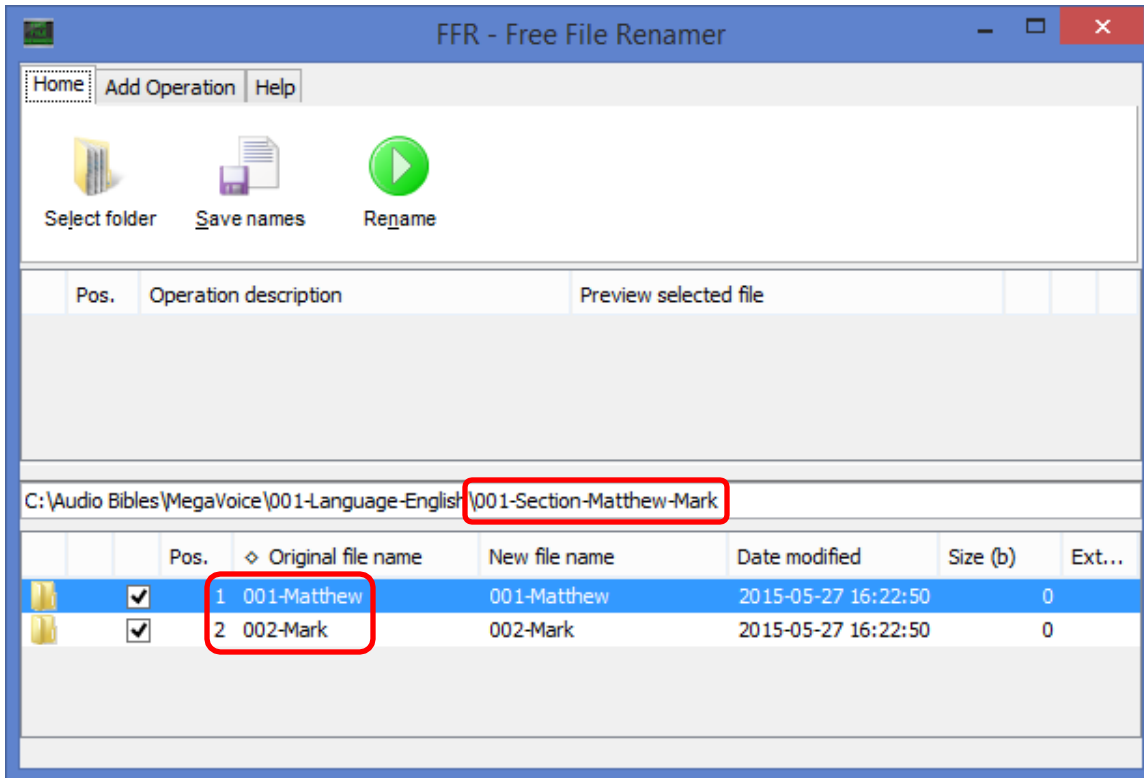

Now let’s define the rules for how we want to rename all the relevant folders. Go to the “Add Operation” tab and click the “Remove” icon.

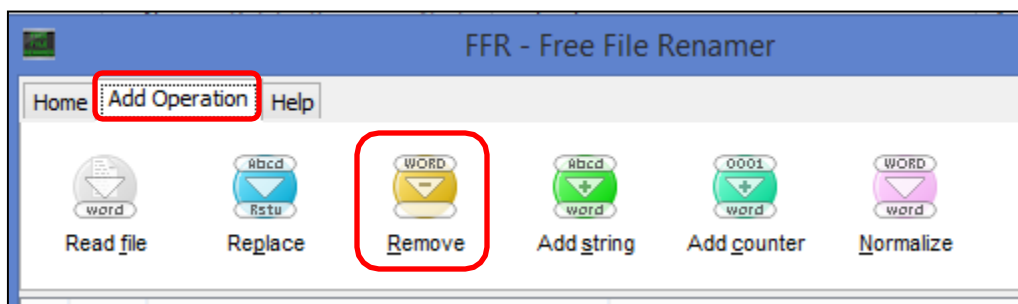

The “Add Operation: Remove” dialog appears. Make sure “Remove all” is checked and click the “Add” button.

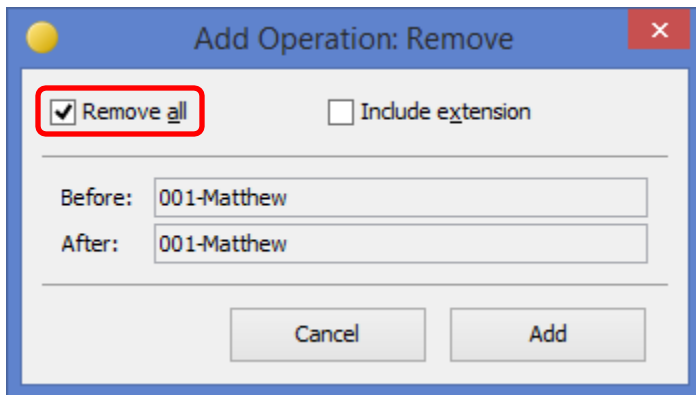

Making sure we are still on the “Add Operation” tab, click the “Add counter” icon.

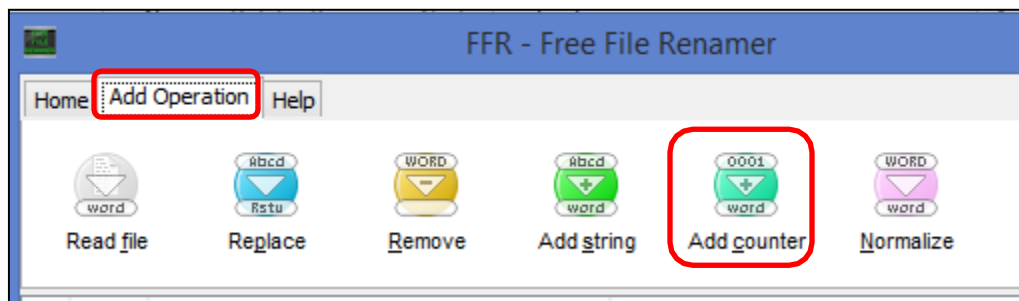

The “Add Operation: Add sequence” dialog appears. Change the “Start” field to “1”. Leave the rest of the fields to default and click the “Add” button.

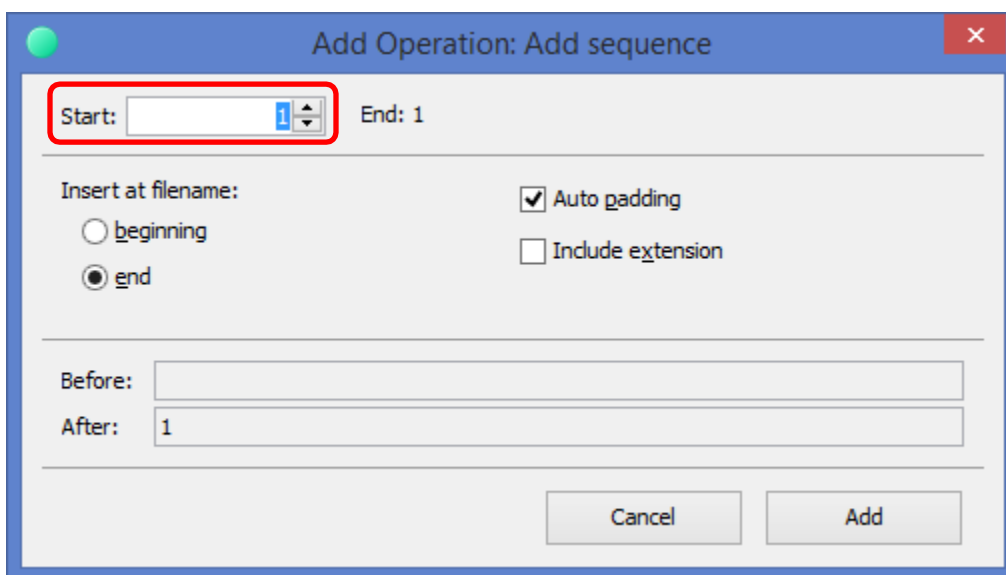

Still on the “Add Operation” tab, click the “Add string” icon.

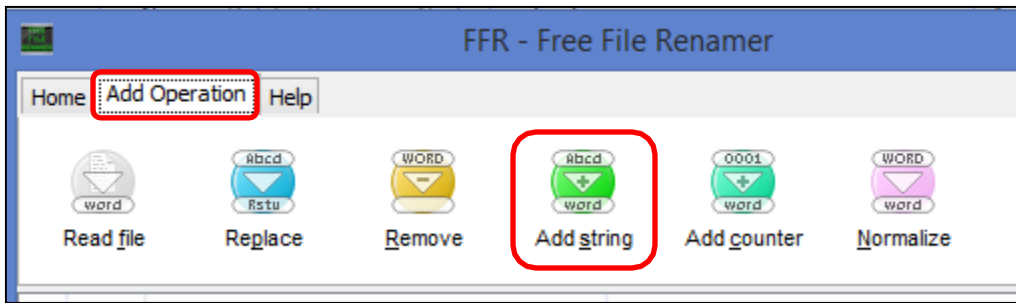

The “Add Operation: Add string” dialog appears. Here we are going to determine how many leading zeroes to add. Note that this must be a “per folder” determination. If there are fewer than 10 folders to rename (in the currently selected folder), type “00” (2 zeroes) in the first field. But if there are 10 or more, type a “0” (single zero) in it. Once you set that value and click anywhere else on the dialog, the “Before/After” display at the bottom of the dialog will show you the results. Click the “Add” button.

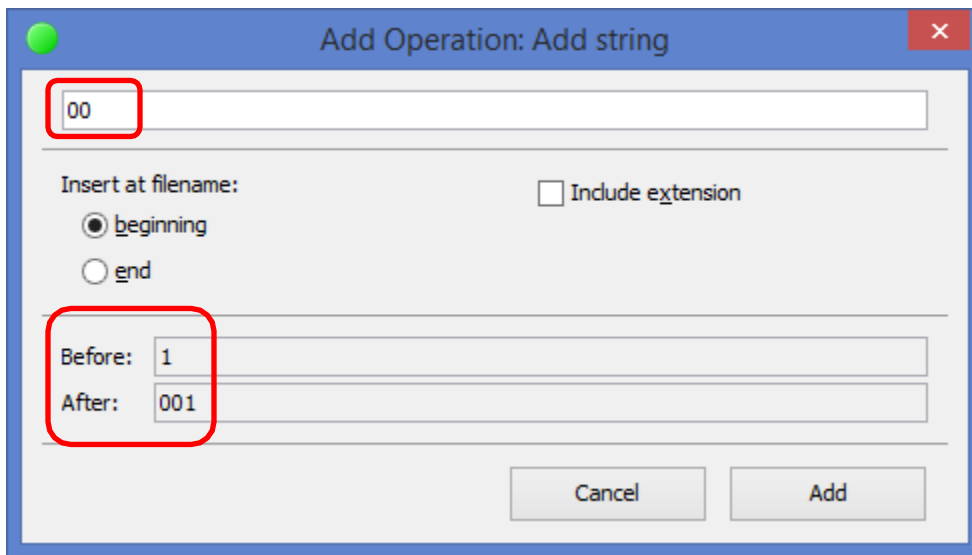

We have now added the “operations” necessary to rename the 2 Book folders. Returning to the main screen, we see the 3 operations we added listed in order. We can also verify that our operations are correct by comparing the “Original file name” column against the “New file name” column in the list at the bottom of the screen. In this case, the “001-Matthew” folder will be renamed to “001” and “002-Mark” will be renamed to “002” – exactly what we want.

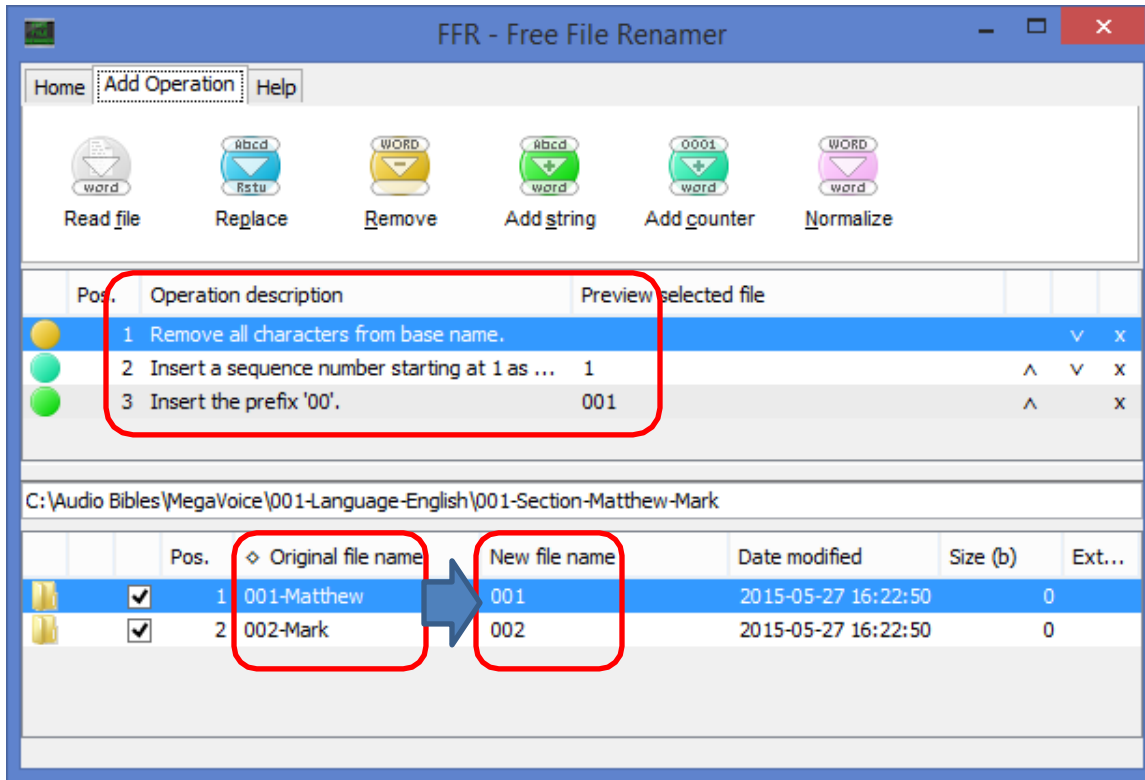

Click on the “Home” tab, and then click the “Rename” icon.

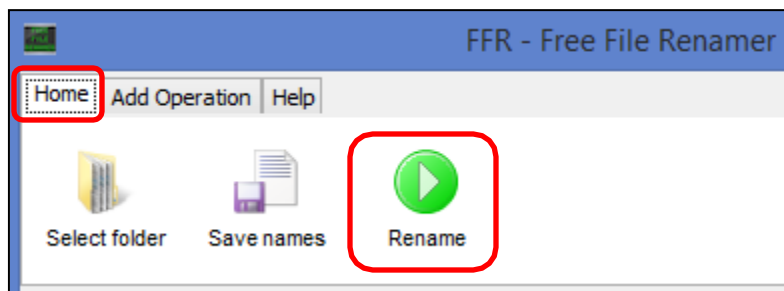

The “Confirm” dialog appears. Click the “Yes” button to execute the rename.

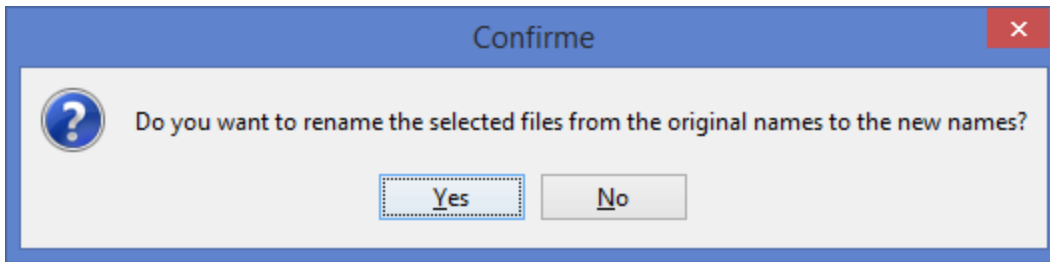

The “success” dialog will appear. Click the “OK” button to continue.

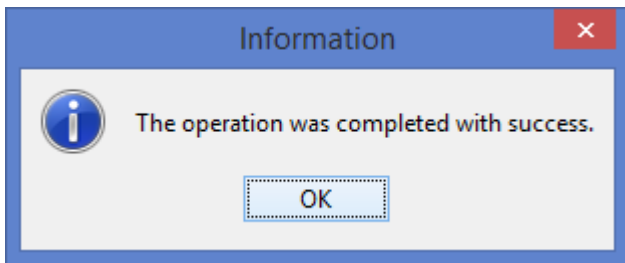

Because the utility *remembers* the renaming operations, all we need to do now is to select the next Section folder (002-Section-1-and-2-Cor) and simply click the “Rename” icon. Repeat this process for the remaining Section 003-Section-Jude-Rev, for the Language folder to rename the 3 Section folders and finally the Audio folder “MegaVoice” to rename the single Language folder.

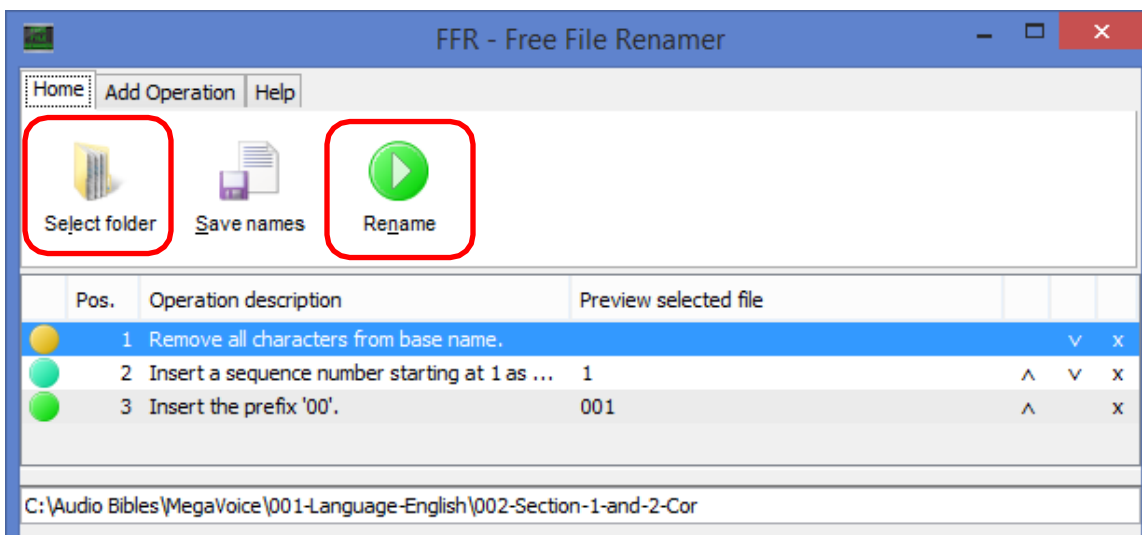

Once we have renamed all the folders in the MegaVoice audio project folder...

This...

Should look like this.

Figure 7: Folder layout before/after renaming

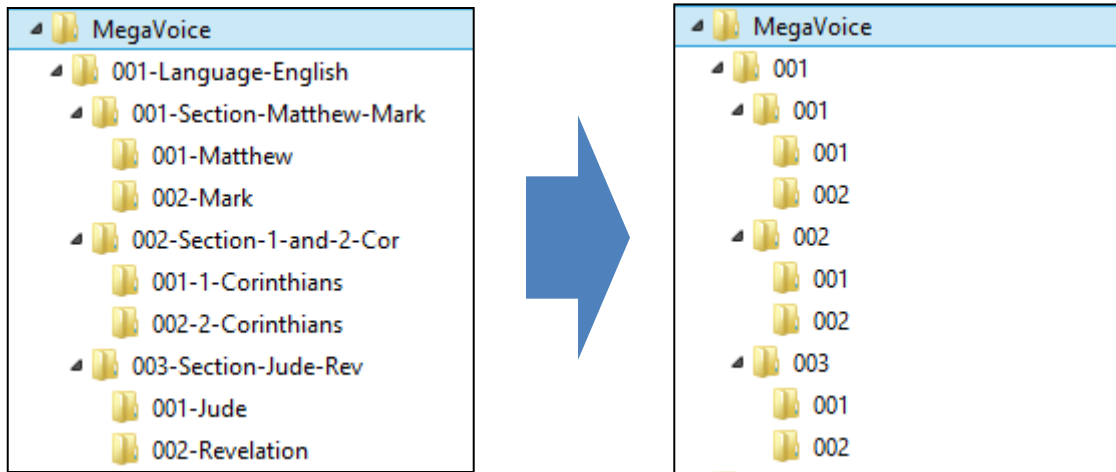

We are ready to load our audio project folder to the Envoy S.

Loading audio files to the Envoy S

Connecting the players for programming

To load your audio files to the Envoy S, it is recommended to use the SaberCopy software program ([provided by MegaVoice](#)).

You may program multiple players at a time, using either multiple USB ports on your PC/Mac or by using a USB expansion HUB. MegaVoice recommends using USB 2.0 (or higher) powered HUBs, each directly connected to the computer (not daisy-chained), and with up to 7 players connected per HUB.



SLS USB cables must be used to connect the players to the PC/Mac. Standard USB to mini-USB cables will not work. When connecting players using a USB HUB each player must have its own SLS USB cable.

See illustration below:

Figure 8: USB connection diagram

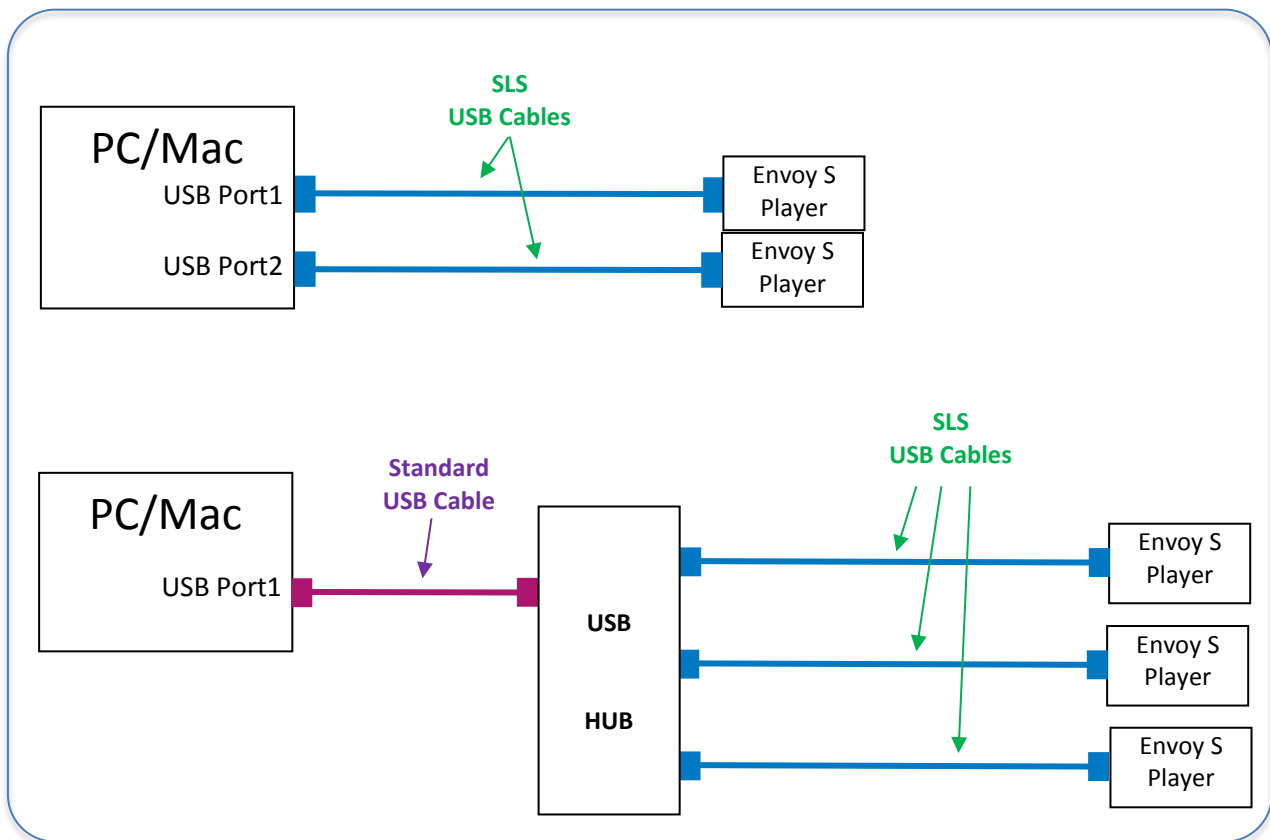

Loading the Audio using SaberCopy

The following example is an excerpt from the user guide [Using SaberCopy to Program MegaVoice Players](#).

In this example, we will program 2 MegaVoice Envoy S players with a small message from our audio library.

1. Connect the players to the computer using the proper SLS cable. SaberCopy usually detects players automatically when they are connected and disconnected. In some cases it does not but all you have to do is to click the “Refresh” button (circled in green) for them to be recognized.
2. There are 2 Envoy S MegaVoice players already connected and SaberCopy has identified them as volumes **D:** and **E:** providing a summary of current content for each (circled in blue).



SaberCopy will also provide you with a lot of information about each connected device that you can't get from most applications. Any time you move the mouse over a player in the list, you will see a tool tip like that to the right:

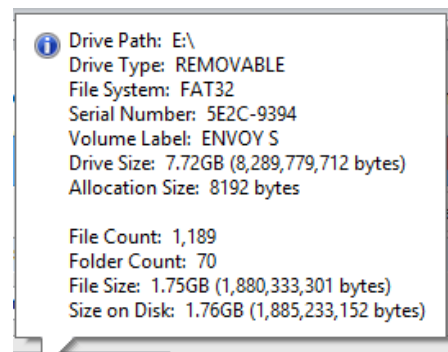

3. One of the nice features SaberCopy provides is that you can always review the contents of a connected player by clicking on the “Open Explorer” icon at the very end of each player line (circled in black).
4. In order to provide the information for the load process we will need to create a new project. Click on the “New Project” button (circled in red).

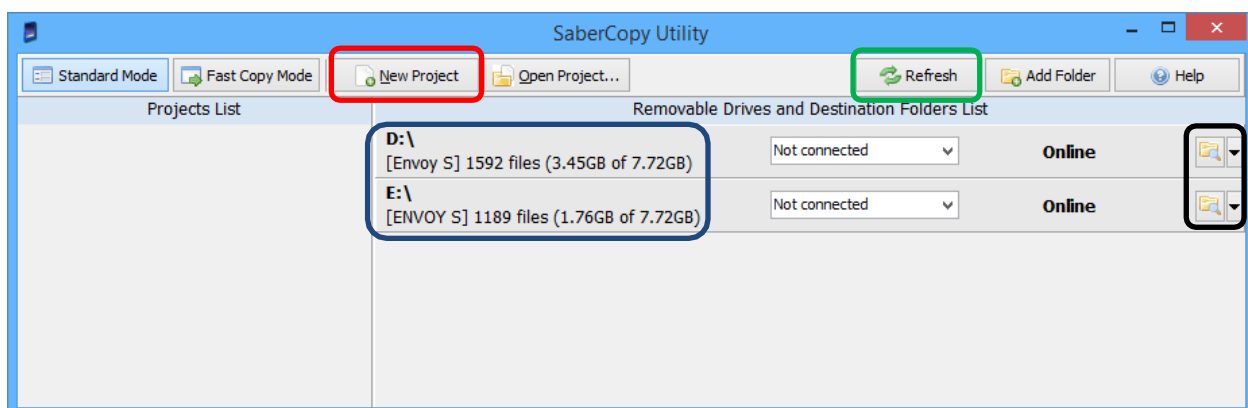

5. The screen image below shows the Project dialog. It consists of 6 tabs, each containing various settings for the project. The first tab, “Files in Project”, is mandatory and is always the first to be displayed.
6. In this example, we want to use the message folder “B1100_cm_samburu” in our “Test Messages” folder.
7. If you intend to save this project so that you can easily re-use it later, add a project title (circled in red). If not, leave the suggested name by SaberCopy (“New Project 1”).



SaberCopy will use the Project Title as the default name for the project file when saving it. It is highly recommended to use the same name for both the external project file name and project title. Make the title meaningful, but not too long. It appears in the drop-down list of options for each player and longer names tend to truncate when displayed in that list.

8. On the “Files in Project” tab, we must specify the source for the copy operation. The easiest way to do this is to drag the desired folder onto the list on the right and drop it. SaberCopy populates the Source File Spec column for us (circled in blue) and the Destination Folder column (circled in green).
 - Alternatively, you can highlight your audio message folder on the left and then click on the “Add” button at the very bottom of the screen (not shown here but also explained in detail in [Example 8 of the full SaberCopy document](#)).

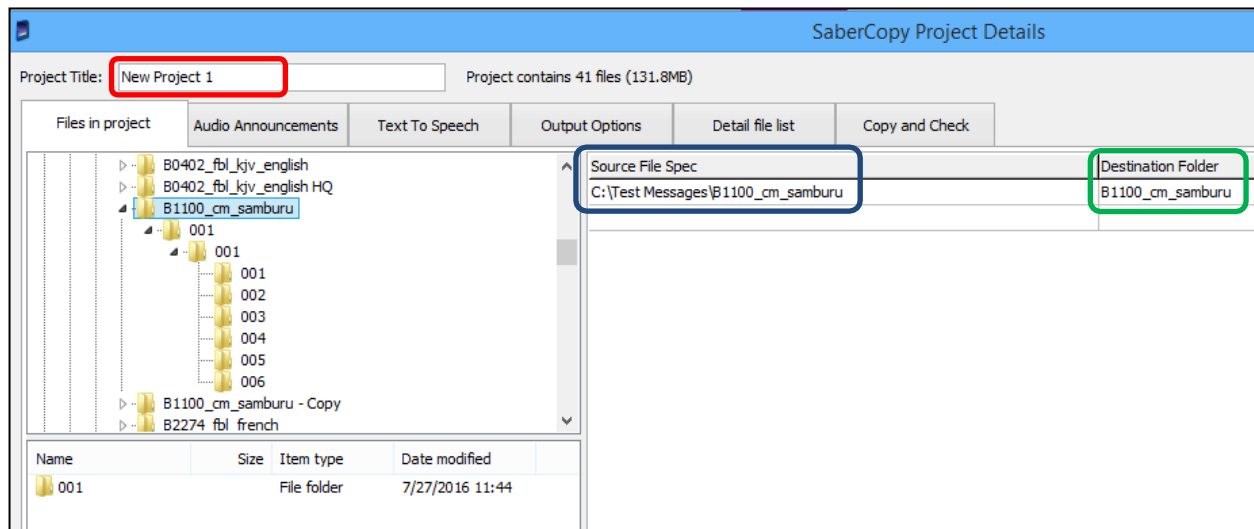

9. Because we want the folders and files in the source folder to be duplicated exactly to the players, we need to clear the “Destination Folder” field so that it is blank (as in the image below). This tells SaberCopy to duplicate the contents of the folder in the “source” to the “root” of each target player. This is the equivalent of specifying “*.*” for “all files”.

Source File Spec	Destination Folder
C:\Test Messages\B1100_cm_samburu	

- Next, click on the “Output Options” tab (circled in red). You will get a screen similar to that below.
- The first time this screen is displayed after starting the application, these are settings initially shown as suggested default values.



On most of the project tabs, SaberCopy will suggest values from the last project opened as defaults. It is always a good idea to verify the settings on each of the tabs to make sure they are what you want any time you begin a new project.

- For the Envoy S players, we just need to make sure that “Target Device” is set to “Standard MP3 Player, Smartphone, Tablet, USB”.
- The “Custom Options” section in the bottom of the screen is addressed in more detail in [Example 2 of the full SaberCopy document](#).

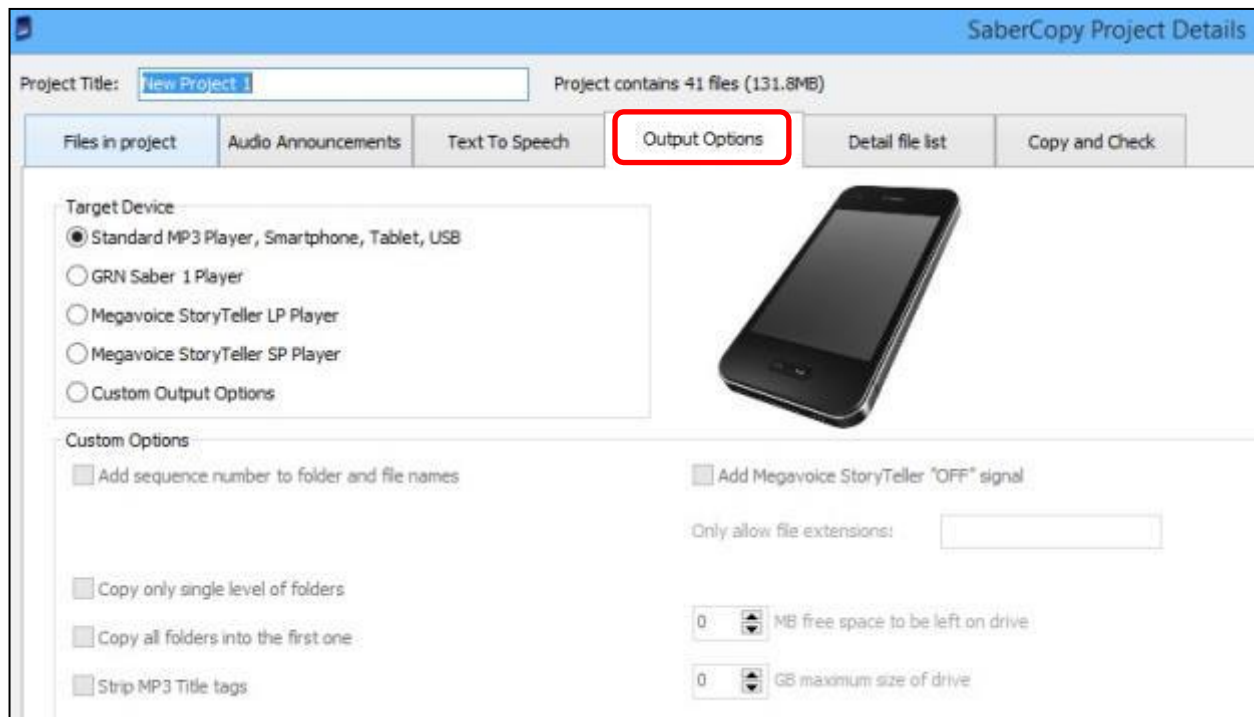

14. Now click on the “Copy and Check” tab. You will be presented with a screen like that below.
15. Notice the project name was changed to something meaningful - “B1100”.
16. In the top right, there are initialization options. For this example, we want Quick Format which will clear all current contents.



When either of the format options is chosen, you may also specify the “File System” and “Allocation Unit Size”. In the majority of cases, this should be left set to “No change” for both because the player should already be configured properly. You can, however, change it to one of the available choices, but we strongly recommend first consulting MegaVoice technical support for optimum settings.

17. Under “Test and Copy Options”, we want to execute the “read/write test before copying”.
18. Under “Verification Options” we want to perform some basic verification once the copy completes so we have checked “Verify everything, don’t stop on error”, “Check file timestamps” and to compare the first 4K of each file on each player against the same in the source.



SaberCopy uses an MD5 checksum calculation for the file contents verification. Note that there are more complex options available for file verification (First 64K, Whole file). The more complete the verification the longer the process takes.

19. When finished, click the OK button to close the Project Details dialog.

Figure 9: SaberCopy Copy and Check options

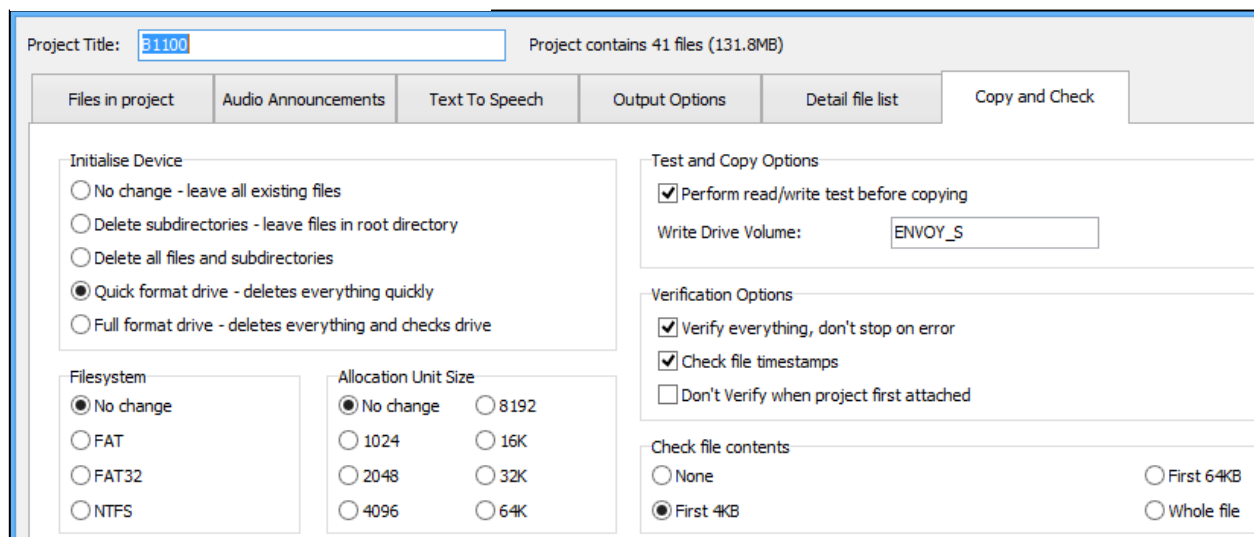

Project Title: Project contains 41 files (131.8MB)

Files in project | Audio Announcements | Text To Speech | Output Options | Detail file list | **Copy and Check**

Initialise Device

- No change - leave all existing files
- Delete subdirectories - leave files in root directory
- Delete all files and subdirectories
- Quick format drive - deletes everything quickly
- Full format drive - deletes everything and checks drive

Filesystem

- No change
- FAT
- FAT32
- NTFS

Allocation Unit Size

- No change
- 8192
- 1024
- 16K
- 2048
- 32K
- 4096
- 64K

Test and Copy Options

- Perform read/write test before copying

Write Drive Volume:

Verification Options

- Verify everything, don't stop on error
- Check file timestamps
- Don't Verify when project first attached

Check file contents

- None
- First 4KB
- First 64KB
- Whole file

20. At this point, the main screen should look like the example below.
21. Now we need to set the “source” of the copy for each player. When all the players connected are being loaded from the same source, the easiest thing to do is to click on the “Attach All” button in the project (circled in blue). SaberCopy will assign all of them (no matter how many) to the project for you.
22. Alternatively, within the line for each player, we could click on the drop-down list and change the setting for each individually to the project “B1100” (circled in red).

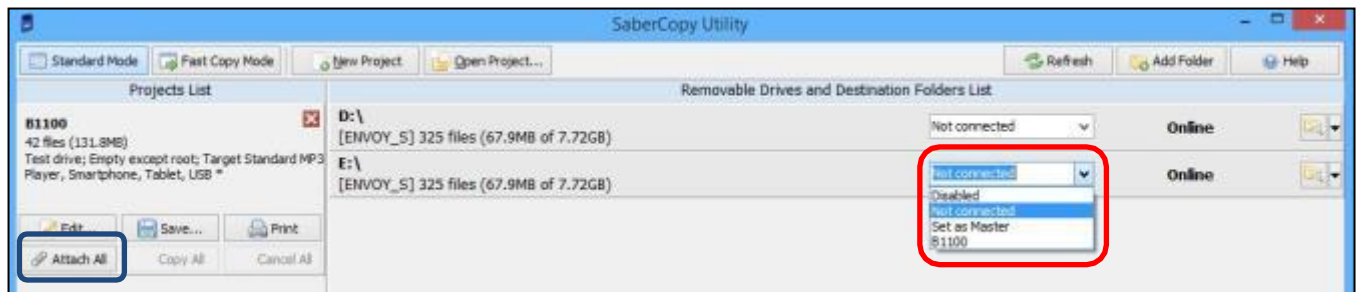

23. Notice that the rows containing the players turned red. This is because SaberCopy will perform a compare *before and after* loading a player from a project (*unless* you check the option “Don’t verify when project first attached” in the project definition). These particular players were loaded with audio different from the B1100 project so they display as “Unmatched”.
24. To begin the copy process, all we need to do now is click on the “Copy All” button (circled in red).



The “Copy All” button in the project will not be enabled until *at least one* of the players in the list is attached to it as the source for the copy process.

25. Note that you could also click on the “Copy” button appearing in each player line (circled in green), but using “Copy All” is a bit more convenient when you want to load all of the connected/selected players and not just some of them.

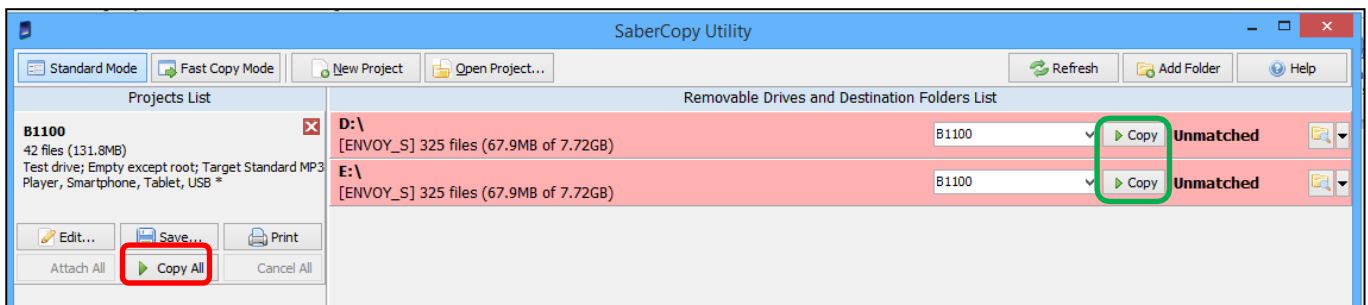

26. When you use “Copy All”, you will get a single pop-up confirmation dialog listing all of the assigned players warning that the current content will be deleted. If this is OK, click “Yes” to continue; otherwise, you can click “No” (don’t delete anything but continue the copy), or “Cancel”. When using the individual “Copy” button per player, a pop-up dialog is displayed for each player separately.

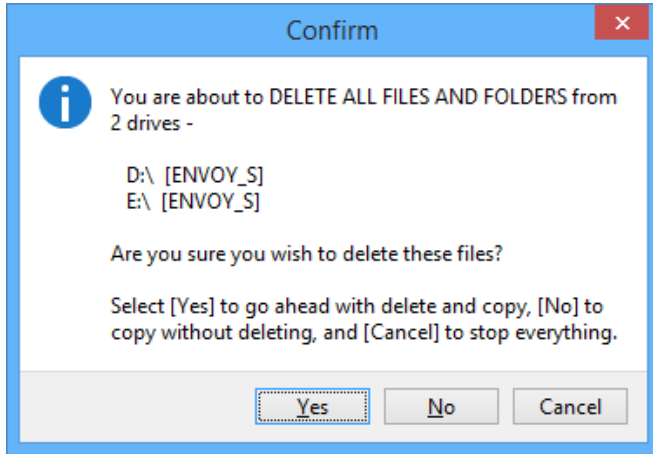

27. Once the actual copy completes, SaberCopy performs another compare of the project against the selected players. If they match, the line for that player will turn **green** and the final message will be “Complete”. If they do *not* match (for some reason), the line for the player will be **red** and the final message will be “Unmatched”. For details on researching “Unmatched” see Example 9 in the full SaberCopy User Guide.

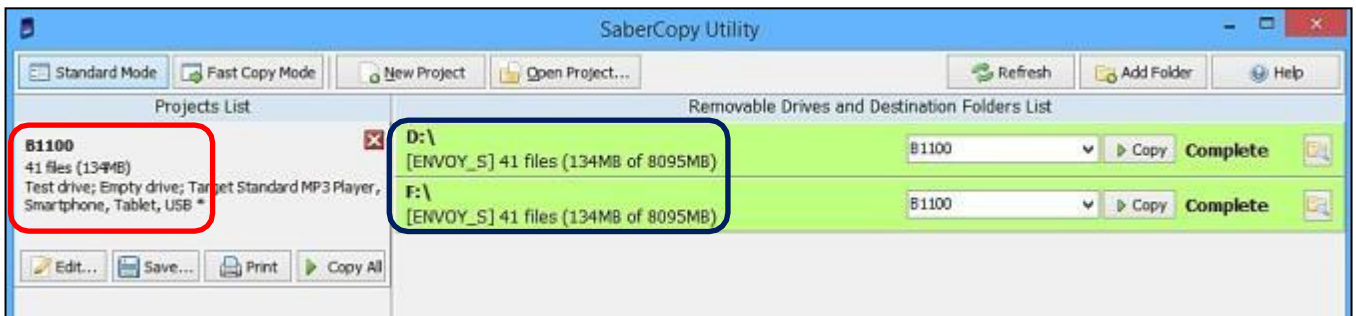

28. Disconnect the players and test each to see that the audio plays as expected.

Listen to the message

After disconnecting each player, you can listen to the message by holding down the ON/OFF button for one second and your message should begin to play automatically. If it does not, see the Section on [Troubleshooting](#) at the end of this document.

Figure 10: On/Off button



The Bookmark



Setting the Bookmark

To set the bookmark, while in playback mode briefly press the  (pause) button. The player will beep once and be placed in pause mode. The bookmark is now set to the current position.

You may press the pause button briefly to resume playback or turn the player off by pressing the  (power) button.

The next time the player is turned on, playback will resume from the bookmarked position.

Resetting the Bookmark to the beginning

To reset the bookmark to the beginning of the message, while in playback mode, briefly press the  (pause) button to place the player in pause mode (the LED will blink intermittently). Then, while paused, press and hold the  (volume up) button until the player beeps once. The bookmark is now reset to the beginning of the message.

You may briefly press the  (pause) button to resume playback or turn the player off.

The next time the player is turned on, playback will start from the *beginning* of the message.

Battery care and charging

With proper care, the player's Lithium-Ion battery should perform well for several years. When shipped, the battery is only partially charged. You can easily charge the player using one of the methods below:



For fastest charge, connect any standard "USB" charger (regulated +5VDC, minimum 300mA) to the mini-USB port on the player for about 2 hours (or until the LED stops blinking). While charging, the LED will blink.



Plug the player into any standard computer USB port using a "USB to mini-USB" cable for about 3 hours or until the LED stops blinking. Any MegaVoice SLS, regular or charge-only cable is sufficient.



For solar charging, place the player with the solar panel facing bright sunlight for at least 8 hours.

Before storing the player for prolonged periods, make sure the battery is at least partially charged. If stored for extended periods, it is recommended to recharge the player *at most* every 6 months in order to prevent the battery from losing its ability to charge. For optimum battery life, try to store the player at room temperature or cooler.

Should the battery become damaged and unable to accept a charge, you can still operate the player using the power cord (charger).

Charging and communication modes

When connecting the player to a computer, it can be done in one of two modes: charging or communication.

* Changing to *computer communication mode* is essential to allow programming of the player.

Connecting a player to a computer for programming purposes:

Connect the player to a computer using a mini-USB SLS cable (for Onboard / microSD programming) or Standard mini -USB Data cable (for microSD programming only). The player will automatically enter *computer communication mode**.

* While in *computer communications mode*, the player will be charging as well.

Connecting a player to a computer for charging purposes:

Connect the player to a computer using a mini -USB SLS cable, a Standard mini -USB Data cable or a Charge Only mini -USB cable.

- If connected via SLS/Data cable, and you want to disconnect from computer communication mode and continue charging your player, press briefly on the Power button on the side of the player or eject the player's volume via the operating system. If the player was on prior to connecting it to the computer, the player will return to the mode it was last in.
 - For the computer to recognize the player again, the player will need to be unplugged from the computer, and reconnected.
- Depending on the connection type, and the player's battery level, the LED will blink (indicating communication activity)
- Physically unplugging the player from the computer will stop the battery charging process.

Warnings and advisories



Make sure to set the volume at the lowest level that can be heard comfortably. Prolonged exposure to loud sound can cause gradual hearing loss.



DO NOT expose the player or battery to fire or extreme heat.



Stop use if you observe abnormal heat, odor, discoloration, leakage or deformation, especially near battery. Refer to a qualified technician for service.



If the battery is removed from the player, handle it with care. Keep the exposed battery out of reach of children. **DO NOT** burn, puncture, disassemble, or modify the battery.



If the battery leaks, dispose of it carefully in accordance with all local laws. Wash any skin or clothing exposed to battery liquid and avoid swallowing or contact with eyes. In the case of swallowing or contact with eyes, seek medical care immediately.

MegaVoice limited warranty

MegaVoice Ltd. (“MegaVoice”) warrants that the retail hardware product herein (“Product”) is free of material defects in materials and workmanship that result in Product failure during normal usage, according to the following terms and conditions:

1. The limited warranty extends only to the original end-user purchaser and holder of this warranty (“You” or “Your”) and is not transferable or assignable to any subsequent purchaser.
2. You must provide proof of purchase of the Product by a dated itemized receipt to be eligible for this limited warranty.
3. The limited warranty is **ONLY** applicable in the country or territory where the product was purchased from an authorized MegaVoice retailer and excludes any product that has not been purchased as new or is obtained as a result of the purchase of a non-MegaVoice product.
4. During the Warranty Period (as provided below), MegaVoice will repair, or replace, at MegaVoice sole option, any defective parts or any parts that will not properly operate for their intended purpose with new or refurbished parts if such repair or replacement is needed.
 - a) The limited warranty for the Product extends for **one (1) year** from the date of customer purchase (“Warranty Period”). The warranty period will be extended by each whole day that the Product is out of your possession for repair under this warranty.
 - b) MegaVoice will pay for the labor charges incurred by MegaVoice in repairing or replacing the defective parts during the warranty period.
 - c) You will not have to pay for any such replacement parts.
 - d) MegaVoice also warrants that the repaired or replaced parts will be free from defects in material and workmanship for a period of NINETY (90) days from the date of repair or replacement, or for the remainder of the Warranty Period, whichever is greater.
5. MegaVoice does not warrant uninterrupted or error-free operation of the Product. MegaVoice is not under any obligation to support the Product for all operating environments, including but not limited to, interoperability with all current and/or future versions of software or hardware.
6. If a problem develops during the Warranty Period, please contact MegaVoice for instructions on where to send the product.
 - a) You must provide proof of purchase of the Product by a dated itemized receipt.
 - b) You will bear the cost of shipping the Product to MegaVoice. MegaVoice will bear the cost of shipping the Product back to you after completing the warranty service.
 - c) Only return the defective item(s). MegaVoice is not responsible for other products or accessories returned with the defective item.

7. The limited warranty does not apply to:
- a) Damage caused by normal wear and tear, abnormal use or conditions, misuse, neglect, abuse, accident, improper handling or storage, exposure to moisture, unauthorized modifications, alterations, or repairs, improper use of any electrical source, undue physical or electrical stress, operator error, non-compliance with instructions or other acts which are not the fault of MegaVoice, including damage or loss during shipment.
 - b) Damage from external causes such as floods, storms, fires, sand, dirt, earthquakes, an Act of God, weather, moisture, heat, or corrosive environments, electrical surges, battery leakage, theft, or damage caused by the connection to other products not recommended for interconnection by MegaVoice.
 - c) Any Product that has had its serial number altered, defaced or removed.
 - d) Any defect occurring after the expiration of the Warranty Period or where MegaVoice was not advised in writing of an alleged defect or malfunction within seven (7) days after the expiration of the Warranty Period.
8. MegaVoice limit of liability under the limited warranty is the actual cash value of the Product at the time you return the Product for repair (e.g., the purchase price of the Product less a reasonable amount for usage). MegaVoice will not be liable for any other losses or damages. These remedies are your exclusive remedies for breach of warranty. Any action or lawsuit for breach of warranty must be commenced within eighteen (18) months following the purchase of the Product.
9. THE FOREGOING LIMITED WARRANTY IS YOUR SOLE AND EXCLUSIVE REMEDY AND IS IN LIEU OF ALL OTHER WARRANTIES, EXPRESS OR IMPLIED. TO THE EXTENT PERMITTED BY APPLICABLE LAW, MEGAVOICE HEREBY DISCLAIMS THE APPLICABILITY OF ANY IMPLIED WARRANTY OF MERCHANTABILITY, FITNESS FOR A PARTICULAR PURPOSE OR USE FOR THE PRODUCT. IF SUCH A DISCLAIMER IS PROHIBITED BY APPLICABLE LAW, THE IMPLIED WARRANTY IS LIMITED TO THE DURATION OF THE FOREGOING LIMITED WRITTEN WARRANTY.
10. MEGAVOICE WILL NOT BE LIABLE FOR ANY INDIRECT, INCIDENTAL, SPECIAL, PUNITIVE OR CONSEQUENTIAL DAMAGES, OR DAMAGES, INCLUDING BUT NOT LIMITED TO ANY LOST PROFITS, SAVINGS, DATA, OR LOSS OF USE, ANY THIRD PARTY CLAIMS, AND ANY INJURY TO PROPERTY OR BODILY INJURY (INCLUDING DEATH) TO ANY PERSON, ARISING FROM OR RELATING TO THE USE OF THIS PRODUCT OR ARISING FROM BREACH OF THE WARRANTY, BREACH OF CONTRACT, NEGLIGENCE, TORT, OR STRICT LIABILITY, EVEN IF MEGAVOICE HAS BEEN ADVISED OF THE POSSIBILITY OF SUCH DAMAGES.
11. This warranty gives you specific legal rights. You may also have other rights, which vary from state to state and country to country. Some states and countries do not allow limitations on how long an implied warranty lasts, or the exclusion or limitation of incidental or consequential damages, so the above limitations or exclusions may not apply to you. This is the entire warranty between You and MegaVoice and supersedes all prior and contemporaneous agreements or understandings, oral or written, relating to the Product, and no representation, promise or condition not contained herein will modify these terms.

Technical Support

The MegaVoice web site: <http://megavoice.com/contact/>

Troubleshooting

Symptom	Cause/Solution
Unit LED does not light up when connected to the computer	<p><i>USB port has not been initialized.</i></p> <ul style="list-style-type: none"> • Switch to a different USBport <p><i>USB HUB is not working</i></p> <ul style="list-style-type: none"> • Make sure the HUB has power • Make sure all USB cables are properly connected <p><i>SLS USB cable might be faulty</i></p> <ul style="list-style-type: none"> • Replace with a working SLS USB cable • Try connecting a different player • Replace the SLS cable with a regular USB charging cable. If the player lights-up, the SLS cable is faulty. <p><i>Player is turned off</i></p> <ul style="list-style-type: none"> • Turn the player on <p><i>Player is faulty</i></p> <ul style="list-style-type: none"> • Replace the player
Unit LED flashes quickly when first connected to the computer with a USB cable	<p><i>Low Battery</i></p> <ul style="list-style-type: none"> • Make sure the battery is charged per the instructions
Unit does not respond or register when connected to the computer with the SLS cable	<p><i>Player may be frozen</i></p> <ul style="list-style-type: none"> • Press the Power button for 10 seconds, until the player resets <p><i>USB port has not been initialized</i></p> <ul style="list-style-type: none"> • Switch to a different USBport <p><i>SLS cable might be faulty</i></p> <ul style="list-style-type: none"> • Replace with a working SLS USB cable

Troubleshooting continued...

Symptom	Cause/Solution
Unit “locks up” during navigation	<p><i>Invalid folder layout</i> <i>Onboard memory is blank</i> <i>Unsupported files encountered</i></p> <ul style="list-style-type: none"> • See structuring rules to make sure the audio message loaded to the player adheres to those rules. • If the folder layout was faulty, reload the player with the corrected folder layout. <p>Reset the player if needed (see “Resetting the player” below). If the folder layout was faulty, reload the player with the corrected folder layout.</p>
Slow “write” speed when programming with SaberCopy software	<p><i>Weak CPU capacity on your computer</i> <i>Too many units connected through a single USB Hub</i> <i>The source audio is somewhere other than the local PC’s hard drive (i.e. on a network computer or portable device)</i></p> <ul style="list-style-type: none"> • Unless you have a high-speed external device where your audio files are stored, we recommend always having your source audio on the local computer’s hard drive when loading players. • We also recommend using <u>powered</u> Hubs, with each Hub directly connected to the computer (not daisy-chained together) with up to 7 players connected per Hub. <p><i>Allocation unit size is too small</i></p> <ul style="list-style-type: none"> • SaberCopy allows you to specify the allocation unit size when formatting a device. The larger the size, the faster data can be copied. The recommended setting is 8192 KB. • See Figure 9: SaberCopy Copy and Check options for details.
Resetting the player	<ul style="list-style-type: none"> • Hold down the power button for 10 seconds. • If unsuccessful, reconnect to the computer with a USB cable and hold down the power button for another 10 seconds. • If unsuccessful, remove the black screw on the back of the unit and open the battery door. Remove the battery from the Molex connector. Try to reload the player before replacing the battery.
Player beeps 3 times and pauses	<p><i>Invalid file structure</i></p> <ul style="list-style-type: none"> • See structuring rules to make sure the audio message loaded to the player adheres to those rules. • If the folder layout was faulty, reload the player with the corrected folder layout.
Playback is unusually fast	<p><i>Bookmark is corrupt</i></p> <ul style="list-style-type: none"> • See Resetting the Bookmark to the beginning.